

**PHILIPS** **MAGNAVOX**

TV/VCR Combination

CCX133AT   
Easy Taping.

**Owner's Manual**

**I M P O R T A N T !**

Return Your Warranty Registration Card  
Within 10 Days. See Why Inside.

# Return your Warranty Registration card today to ensure you receive all the benefits you're entitled to.

Once your PHILIPS MAGNAVOX purchase is registered, you're eligible to receive all the privileges of owning a PHILIPS MAGNAVOX product. So complete and return the Warranty Registration Card enclosed with your purchase at once. And take advantage of these important benefits.

## Warranty Verification

Registering your product within 10 days confirms your right to maximum protection under the terms and conditions of your PHILIPS MAGNAVOX warranty.

## Owner Confirmation

Your completed Warranty Registration Card serves as verification of ownership in the event of product theft or loss.

## Model Registration

Returning your Warranty Registration Card right away guarantees you'll receive all the information and special offers which you qualify for as the owner of your model.

## PHILIPS MAGNAVOX

*Congratulations on your purchase, and welcome to the "family!"*

### Dear PHILIPS MAGNAVOX product owner:

Thank you for your confidence in PHILIPS MAGNAVOX. You've selected one of the best-built, best-backed products available today. And we'll do everything in our power to keep you happy with your purchase for many years to come.

As a member of the PHILIPS MAGNAVOX "family," you're entitled to protection by one of the most comprehensive warranties and outstanding service networks in the industry.

What's more, your purchase guarantees you'll receive all the information and special offers for which you qualify, plus easy access to accessories from our convenient home shopping network.

And most importantly you can count on our uncompromising commitment to your total satisfaction.

All of this is our way of saying welcome-and thanks for investing in a PHILIPS MAGNAVOX product.

Sincerely,



Robert Minkhorst  
President and Chief Executive Officer

**P.S. Remember, to get the most from your PHILIPS MAGNAVOX product, you must return your Warranty Registration Card within 10 days. So please mail it to us right now!**



Know these

## safety symbols



 This "bolt of lightning" indicates uninsulated material within your unit may cause an electrical shock. For the safety of everyone in your household, please do not remove product covering.

 The "exclamation point" calls attention to features for which you should read the enclosed literature closely to prevent operating and maintenance problems.

**WARNING:** TO PREVENT FIRE OR SHOCK HAZARD, DO NOT EXPOSE THIS EQUIPMENT TO RAIN OR MOISTURE.

**CAUTION:** To prevent electric shock, match wide blade of plug to wide slot, and fully insert.

**ATTENTION:** Pour éviter les chocs électriques, introduire la lame la plus large de la fiche dans la borne correspondante de la prise et pousser jusqu'au fond.

### For Customer Use

Enter below the Serial No. which is located on the rear of the cabinet. Retain this information for future reference.

Model No. \_\_\_\_\_  
Serial No. \_\_\_\_\_

**PHILIPS MAGNAVOX** Visit our World Wide Web Site at <http://www.magnavox.com>

---

### Welcome to your TV/VCR owner's manual.

This manual has six sections: Setting Up Your TV/VCR; Description of Controls; Basic Operations; Recording Options; Playing Options; and Information You May Need. The instructions explain all of the TV/VCR's features, which are listed below. You cannot hurt your TV/VCR by trying the features! So read on – and relax.

### Features

- HQ (High Quality) System
- Automatic Channel Programming
- On-Screen Displays in English or Spanish
- Automatic Tracking Adjustment
- One Touch Recording
- Unattended (Timer) Recording
- Special Effects Playback: Forward and Reverse Searching; Still
- Remote Control
- Automatic Operation Features
- Closed Caption System
- Automatic Clock Setting
- Daylight-Saving Time
- VCR Plus+ Programming System
- Smart Sound

### Safety Precautions

**Warning: To prevent fire or shock hazard, do not expose this equipment to rain or moisture.**

**FCC Warning: Any unauthorized changes or modifications to this equipment void the user's authority to operate it.**

This TV/VCR, equipped with a HQ (High Quality) system, is compatible with existing VHS (video home system) equipment.

**Philips Consumer Electronics Company** recommends that you use only video cassette tapes that have been tested and inspected for use in **VHS** two, four, six, and eight hour VCRs, and which are labeled with the **VHS** mark. The use of tapes that have not been inspected for use in two, four, six, and eight hour VCRs may result in poor picture quality and excessive deposits on the video heads, which may not be covered by the warranty if damage occurs.

**Note to the Cable TV System Installer:** This reminder is provided to call the Cable TV system installer's attention to Article 820-40 of the National Electrical Code, which provides guidelines for proper grounding – in particular, specifying that the cable ground shall be connected to the grounding system of the building, as close to the point of cable entry as possible.

Copyright 1997 Philips Consumer Electronics Company. All rights reserved. VCR Plus+ and PlusCode are trademarks of Gemstar Development Corporation. The VCR Plus+ system is manufactured under license from Gemstar Development Corporation.

### Helpful Hint

- *Before doing anything else, record the TV/VCR's model and serial numbers in the spaces provided on page two. These numbers will help us assist you if you ever call for help.*

## 4 Table of Contents

---

### Setting Up Your TV/VCR

Introduction	3
Table of Contents	4
Before Using the TV/VCR	5
Hooking Up the TV/VCR	6 - 7
Turning On the TV/VCR	8
Language Selection	9
Channel Memory	10 - 11
Setting the Clock	12 - 17
Daylight-Saving Time	18
Time Zone	19

### Description of Controls

Front Panel	20
Rear Panel	21
Remote Control Buttons	22 - 23
Adjusting the Picture Controls	24 - 25
On-Screen Displays	26
Reminder	27

### Basic Operations

Playing	28
Recording	29

### Recording Options

One Touch Recording	30
Rerecording (Tape Duplication)	31
Timer Recording	32 - 35
Setting Up the VCR Plus+ Programming System	36 - 37
Timer Recording With the VCR Plus+ Programming System	38 - 39
Record Defeat	40

### Playing Options

Setting the Sleep Timer	41
Closed Captioning	42 - 43
Volume Bar / Smart Sound	44
Repeat Playback	45
A - B Repeat Playback	46 - 47
Real Time Counter Memory	48
Automatic Operation Features	49
Playback Options	50

### Information You May Need

Specifications / Glossary	51
Helpful Hints	52 - 53
Limited Warranty	54
Index	55
Supplied Accessories	56

### Putting Batteries in the Remote Control

1

Remove the battery compartment lid on the bottom of the remote control by sliding it in the direction of the arrow.

2

Place two AA batteries inside the battery compartment with their polarities (+ and - ends) aligned as indicated.

3

Replace the battery compartment lid.

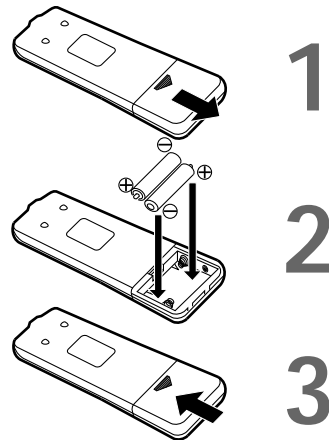

### Removing the Shipping Card

- A shipping card may be inserted in the cassette compartment of the TV/VCR. Before you insert a cassette tape, you must remove the shipping card. To remove the card, open the cassette compartment, then grasp the tape and remove the card.

### Erase Protection

Video cassette tapes have record tabs to ensure that recordings are not accidentally erased.

1

To prevent accidental erasure, break off the tab with a screwdriver.

2

To record again, cover the hole with cellophane tape.

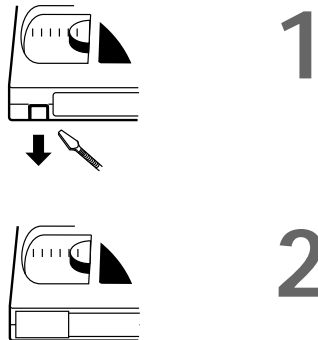

### Using the Remote Control

- Point the remote control at the TV/VCR's remote sensor.
- Do not put objects between the remote control and the TV/VCR.

### VCR Maintenance

- In this TV/VCR, use only tapes with the **VHS** mark.
- Make sure any light adhesive stick-on notes are removed from the video cassette tape before putting the tape in the TV/VCR. Removable labels like these can jam the TV/VCR.
- Periodic maintenance is required to maintain your TV/VCR's continued excellent performance. This TV/VCR has an automatic head cleaning system. However, the video heads will eventually require cleaning or replacement. Cleaning or replacement of the video heads should be performed by an authorized service center.

#### Helpful Hints

- The remote control and its batteries are supplied.
- Do not mix alkaline and manganese batteries.
- Do not mix old and new batteries.

## 6 Hooking Up The TV/VCR

---

### 1

Hook up your TV/VCR using one of the connections shown.

#### A.

##### Hooking Up Your TV/VCR With a Cable Signal or Outdoor Antenna

Connect a Cable signal or an antenna to the ANT(enna) Jack.

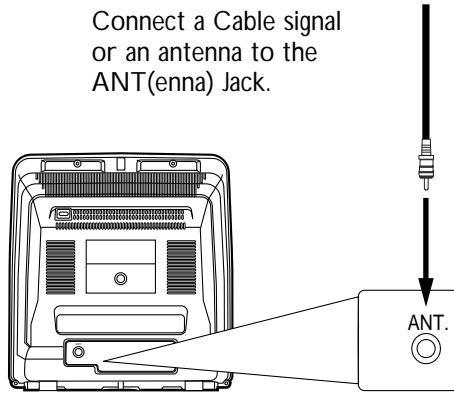

#### B.

##### Hooking Up Your TV/VCR With a Cable Box

To view any channel, set the TV/VCR to the Cable Box output channel (channel 03 or 04). Then, select channels at the Cable Box.

Connect the Cable signal to the IN Jack on the Cable Box.

Connect an RF coaxial cable (75-ohm, not supplied) to the OUT Jack on the Cable Box and to the ANT(enna) Jack on the TV/VCR.

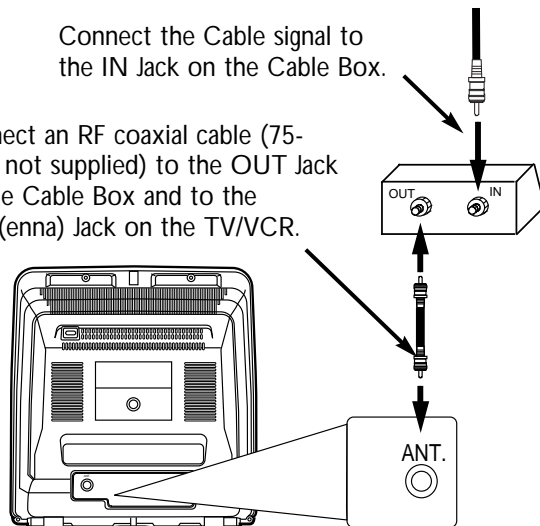

#### C.

##### Hooking Up Your TV/VCR With an Indoor Antenna

To install a rod antenna (not supplied), push the stem of the antenna into the antenna hole on the top of the TV/VCR. Connect the antenna wire to the ANT(enna) Jack on the back of the TV/VCR as shown. Extend the antenna and adjust its length, direction, and angle for the clearest picture.

Rod Antenna  
(not supplied)

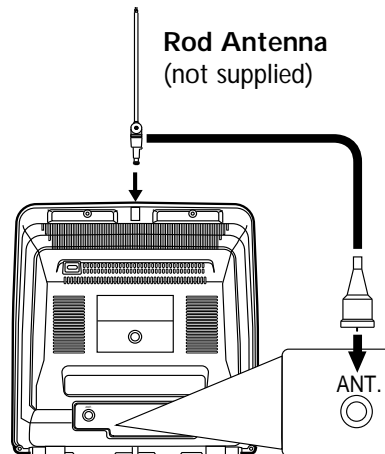

## Hooking Up The TV/VCR (cont'd) 7

### D.

#### Hooking Up Your TV/VCR to Another Video Source (VCR or Camcorder)

You may need this connection if you want to copy tapes. Details are on page 31.

AUDIO/VIDEO OUT Jacks on VCR

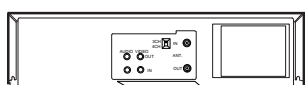

Use an Audio cable to connect the AUDIO OUT Jack on the VCR to the AUDIO Jack on the front of the TV/VCR.

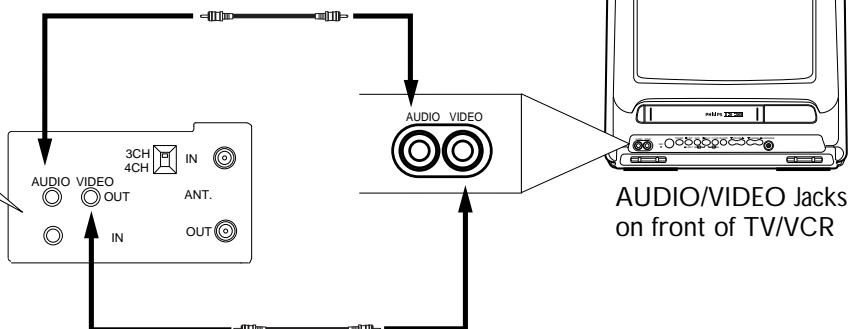

AUDIO/VIDEO Jacks on front of TV/VCR

Use a Video cable to connect the VIDEO OUT Jack on the VCR to the VIDEO Jack on the front of the TV/VCR.

## 2

Plug in the TV/VCR.

## 3

Before you turn on the TV/VCR, go to page eight.

### Helpful Hints

- Before connecting the rod antenna (or mixing adapter or coaxial cable) to the ANT(enna) Jack, make sure the pin is not bent. If the pin is bent, straighten it as illustrated, then connect it to the ANT(enna) Jack.
- A rod antenna (not supplied) is available from Philips Service Company. The part number is 4835 3033 7006. To order, call 1-800-851-8885.
- Audio and video cables are not supplied.

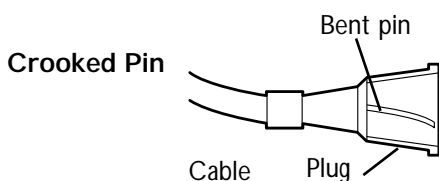

## 8 Turning On the TV/VCR

Before you turn on the TV/VCR, make sure there are batteries in the remote control (details are on page five) and the TV/VCR is hooked up correctly (details are on pages six - seven).

The instructions on this page work only when you turn on the TV/VCR for the first time.

# 1

Press the **POWER** button. The TV/VCR will come on and the language select display screen shown below will appear.

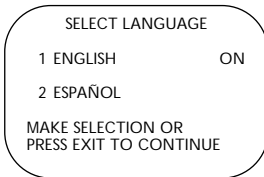

# 2

Press the **Number 1** button to select English on-screen displays or press the **Number 2** button to select Spanish on-screen displays.

# 3

Press the **STATUS/EXIT** button. The channel program display screen shown below will appear.

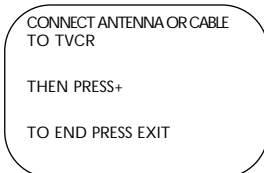

# 4

Press the **F.FWD/+** button to begin automatic channel programming. The TV/VCR will place all of the channels you receive into its memory, so when you scan through channels using the CHANNEL Up/Down buttons, you'll only scan through channels that you receive. When channels are programmed, CHANNELS ARE SET will appear on-screen briefly. Then the TV/VCR will go to the lowest channel programmed.

(If you try to program channels when there is no antenna or cable connected to the TV/VCR, programming will appear to take place, but eventually a NO TV SIGNALS ... message will appear on-screen. Connect an antenna or cable to the TV/VCR, then try again. You may need to follow the steps on pages nine - 11 instead.)

# 5

Now, you may use the CHANNEL Up/Down buttons or the Number buttons on the remote control to select a TV/VCR channel. Use the VOLUME Up/Down buttons to adjust the sound.

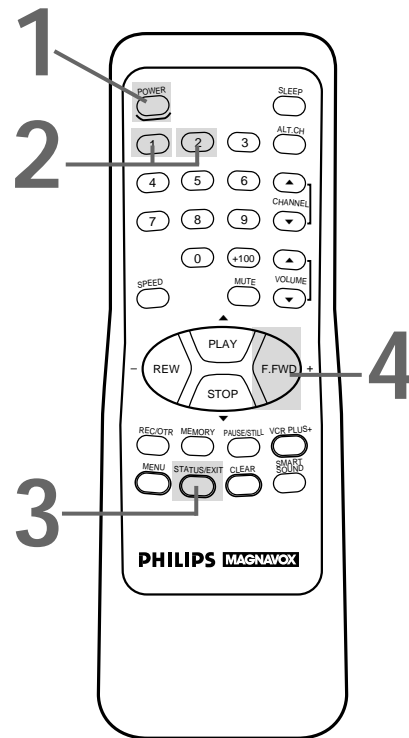

### Helpful Hints

- If you do not see any on-screen displays when you turn on the TV/VCR, check your hook-ups, then try again. If you still do not see any on-screen displays, follow the steps on pages nine - 11 to select a language and program channels.
- To skip this feature and play a tape immediately, insert a tape with its record tab removed. Playback will begin. Or, to skip step 2, press the STATUS/EXIT button before proceeding. All on-screen displays will be in English. To skip step 4, press the STATUS/EXIT button before proceeding. Channels will not be programmed, and CHANNELS NOT SET will appear on-screen briefly.
- You cannot program channels if you are using a Cable Box.
- Line Input mode will always be stored in the TV/VCR's memory as channel 00. When you select channel 00, A/V IN will appear on-screen briefly. Press the CHANNEL Up/Down buttons or Number buttons to select another channel.



## Language Selection 9

Follow the steps below to change the language of the on-screen displays.

# 1

Press the **MENU** button to display the pop up menu.

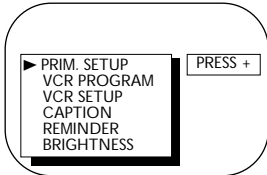

# 2

Press the **PLAY/▲** button or the **STOP/▼** button to select **PRIM. SETUP**. (If the menu is in Spanish, select **PREPARACION**.) Then, press the **F.FWD/+** button.

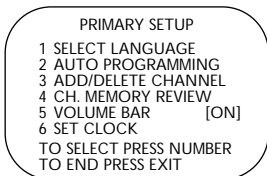

# 3

Press the **Number 1** button to choose **SELECT LANGUAGE**. (If the menu is in Spanish, press the Number 1 button to select **SELECCION IDIOMA**.)

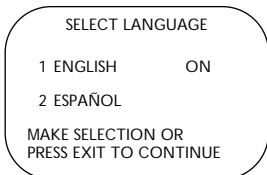

# 4

Press the **Number 1** button if you want the on-screen displays in **English**. **ON** will appear to the right of **ENGLISH** on-screen. **Or**, press the **Number 2** button if you want the on-screen displays in **Spanish**. **SI** will appear to the right of **ESPAÑOL** on-screen.

# 5

Press the **STATUS/EXIT** button.

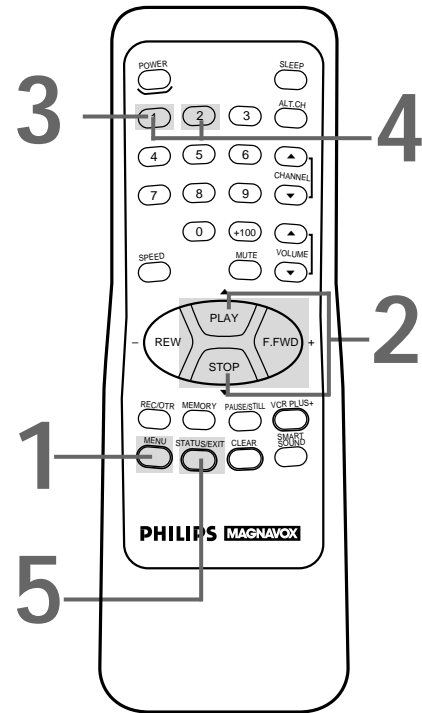

# 10 Channel Memory

Although the TV/VCR may automatically memorize the channels you receive when you turn it on for the first time, you may program channels again. Follow the steps below to program channels.

## 1

Press the MENU button to display the pop up menu.

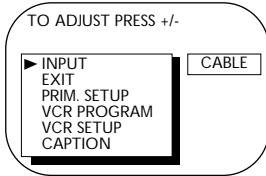

## 2

Press the PLAY/▲ button or the STOP/▼ button to select INPUT. Press the REW(ind)/- button or the F.FWD/+ button until ANTENNA or CABLE (whichever you have) appears to the right of the pop up menu.

## 3

Press the STOP/▼ button repeatedly to select PRIM. SETUP, then press the F.FWD/+ button.

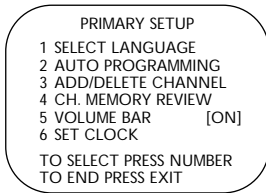

## 4

Press the Number 2 button to select AUTO PROGRAMMING. AUTO PROGRAMMING MEMORIZED CH. ... will appear on-screen. The TV/VCR will place all of the channels you can receive into its memory.

## 5

Wait for a few minutes. When programming is complete, CHANNELS ARE SET will appear on-screen. Then the programming of the lowest channel number placed in the TV/VCR's memory will appear on-screen. Now, when you press the CHANNEL Up/Down buttons, you will scan only through channels you receive.

## 5

Wait for the TV/VCR to program channels.

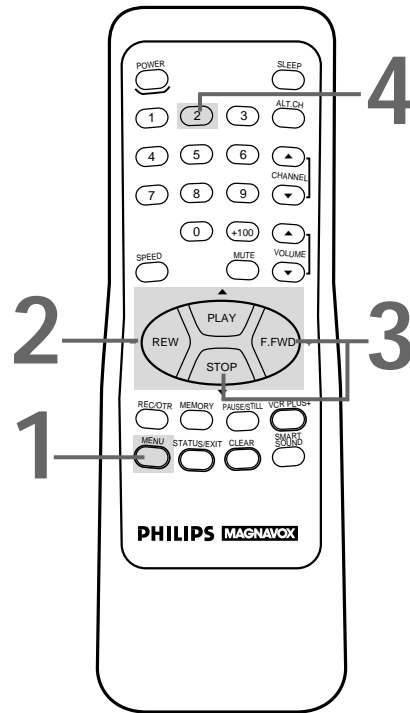

Helpful Hints
<ul style="list-style-type: none"> <li>• Line Input mode will always be stored in the TV/VCR's memory as channel 00. You cannot delete it.</li> <li>• You cannot program channels when the TV/VCR is on channel 00 (A/V IN will be selected at INPUT at step 2). Select ANTENNA or CABLE at step 2.</li> </ul>

## Adding/Deleting Channels

# 1

Press the MENU button to display the pop up menu.

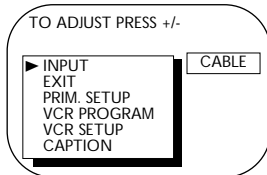

# 2

Press the PLAY/▲ button or the STOP/▼ button to select PRIM. SETUP, then press the F.FWD/+ button.

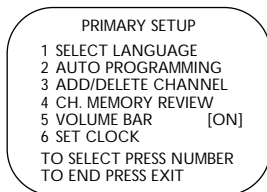

# 3

Press the Number 3 button to select ADD/DELETE CHANNEL.

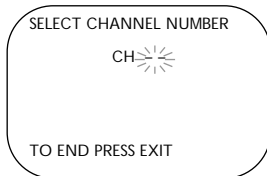

# 4

Enter the channel number you want to add or delete.

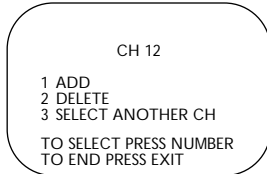

# 5

Within five seconds, press the Number 1 button to add that channel or the Number 2 button to delete that channel. If you do not make a choice within five seconds, you will return to the previous screen. (If you make a mistake, press the Number 3 button to select another channel.)

# 6

Press the STATUS/EXIT button.

Programming of the channel you added or deleted will appear.

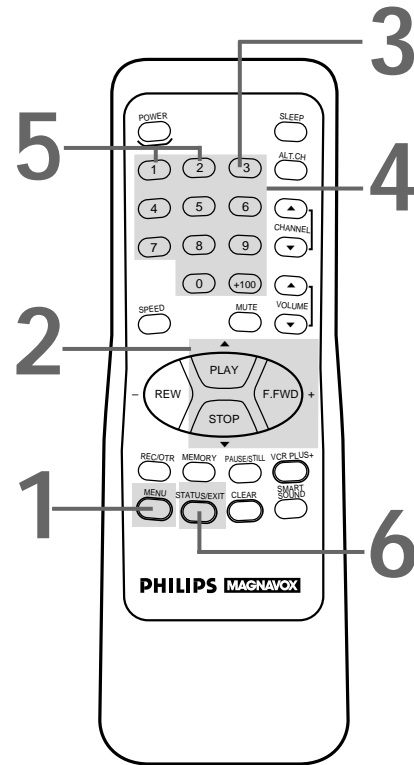

### Helpful Hint

- To review the channels memorized by the TV/VCR, follow these steps.
  - 1) Press the MENU button.
  - 2) Press the PLAY/▲ button or the STOP/▼ button to select PRIM. SETUP. Press the F.FWD/+ button.
  - 3) Press the Number 4 button to select CH. MEMORY REVIEW. A list of programmed channels will appear on-screen.
  - 4) If all the programmed channels don't fit on-screen, press the Number 1 button. If you do not press the Number 1 button within 10 seconds, the remaining channels will appear on-screen. (If there are no remaining channels, the previous menu will appear.) Or press the Number 2 button to see the previous screen of channels.
  - 5) Press the STATUS/EXIT button.

## 12 Setting the Clock

There are three ways to set the clock: Manually, with Automatic PBS Channel Selection, or with Manual PBS Channel Selection. With **manual clock setting**, you tell the TV/VCR the current time. The TV/VCR then adjusts the time accordingly. With Automatic or Manual PBS Channel Selection, the TV/VCR gets the current time from your local PBS station. It updates the time by referring to your PBS station broadcasts. If you use either Manual PBS Channel Selection or Automatic PBS Channel Selection, follow the steps on page 19 to have the TV/VCR update the clock according to your Time Zone.

To set the clock manually, follow the steps on pages 12 -13. To set the clock using Automatic PBS Channel Selection, follow the steps on pages 14 - 15. To set the clock using Manual PBS Channel Selection, follow the steps on pages 16 - 17.

Before you begin, make sure:

- The TV/VCR is hooked up and turned on. *Details are on pages six - eight.*
- Channels are programmed. *Details are on pages 10 - 11.*
- You make each entry within 60 seconds of the previous entry. (If you do not, you may start again at step 1.)

### Manual Clock Setting

# 1

Press the **MENU** button to display the pop up menu.

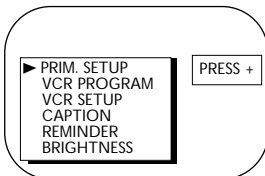

# 2

Press the **PLAY/▲** button or the **STOP/▼** button to select **PRIM. SETUP**. Then, press the **F.FWD/+** button.

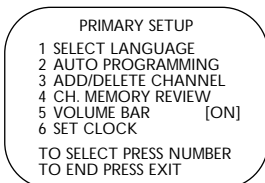

# 3

Press the **Number 6** button to select **SET CLOCK**.

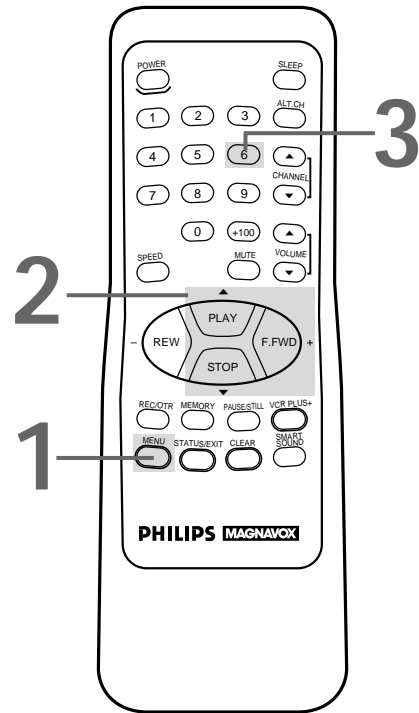
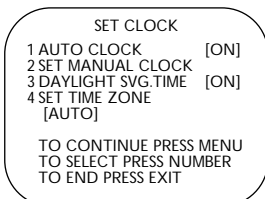

### Helpful Hints

- Entries that do not match the TV/VCR's internal calendar will cause a question mark (?) to appear on the TV/VCR screen.
- To make corrections while you are setting the clock, press the **CLEAR** button until the space for the number you want to correct is flashing. Then enter the correct number.
- To make corrections after you have set the clock, start again at step 1.
- If you press the **STATUS/EXIT** button when you are setting the clock, the TV/VCR will exit Set Clock mode and return to the program you were watching.

# 4

Press the Number 2 button to select SET MANUAL CLOCK.

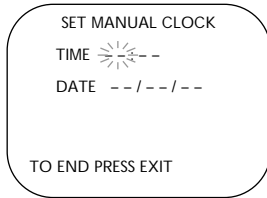

# 5

Press two Number buttons for the hour(s) and two Number buttons for the minute(s). Then press 1 for AM or 2 for PM. For example, for 9:30 PM, press 09, 30, 2.

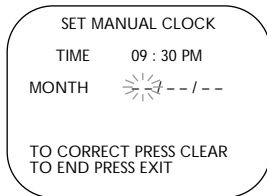

# 6

Press two Number buttons for the month, two Number buttons for the day, and two Number buttons for the year. For example, for July 1, 1997, press 07, 01, 97. The day of the week will appear automatically.

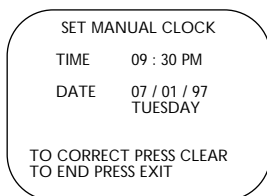

# 7

Press the STATUS/EXIT button to start the clock. The screen will return to the program you were watching.

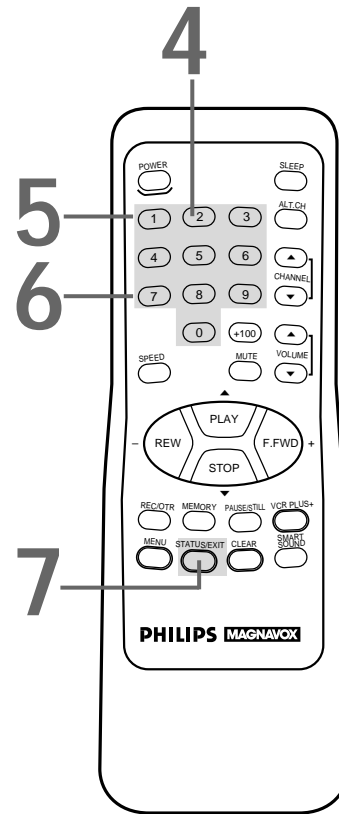

## 14 Setting the Clock (cont'd)

### Automatic PBS Channel Selection

1

Press the **MENU** button to display the pop up menu.

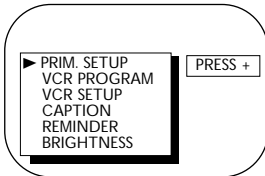

2

Press the **PLAY/▲** button or the **STOP/▼** button to select **PRIM. SETUP**. Then, press the **F.FWD/+** button.

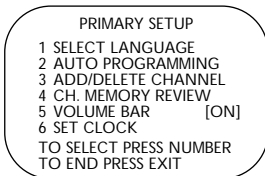

3

Press the **Number 6** button to select **SET CLOCK**.

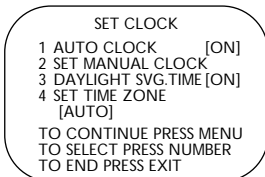

4

If **ON** appears beside **AUTO CLOCK**, press the **MENU** button. If **OFF** appears beside **AUTO CLOCK**, press the **Number 1** button so that **ON** appears to the right of **AUTO CLOCK**, then press the **MENU** button.

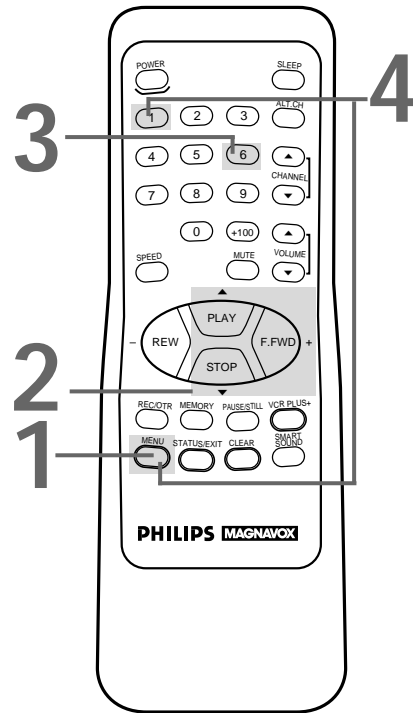
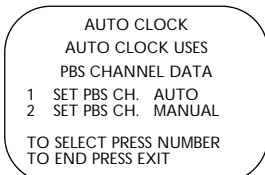

## Setting the Clock (cont'd) 15

# 5

Press the Number 1 button to select SET PBS CH. AUTO.

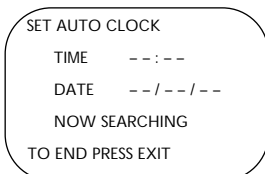

# 6

NOW SEARCHING flashes on the TV/VCR screen. However, you may see the message "PLEASE TURN OFF TO SET AUTO CLOCK PLEASE WAIT SEVERAL MINUTES." If this message appears, turn off the TV/VCR for a few minutes. When you turn on the TV/VCR, the time will be set. If the time is not set, repeat steps 1 - 5. Or, follow the steps on pages 12 - 13 to set the clock manually or pages 16- 17 to set the clock with Manual PBS Channel Selection.

# 7

When the TV/VCR finds the PBS channel, the time will appear on-screen. Press the STATUS/EXIT button.

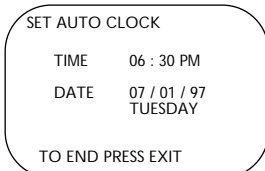

- If CANNOT FIND CLOCK DATA flashes on the TV/VCR screen, you will be prompted to turn off the TV/VCR. Turn off the TV/VCR. Leave it off for several minutes. When you turn on the TV/VCR again, the clock will be set.

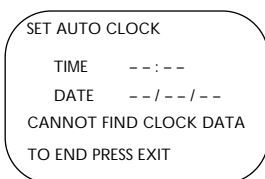

# 6

Wait for the TV/VCR to find the time.

# 5

# 7

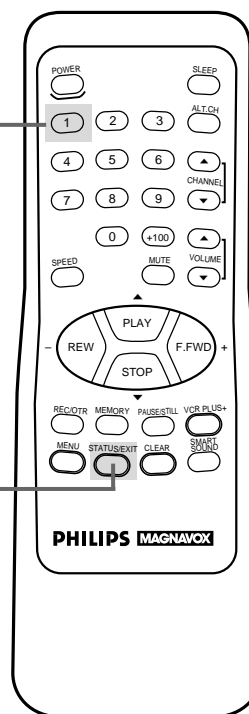

### Helpful Hints

- To display the time, press the STATUS/EXIT button. A status display, which includes the time, will appear on the TV/VCR screen. Details are on page 26.
- If you press the STATUS/EXIT button while you are setting the clock, the screen will exit Set Clock mode and return to the program you were watching. If this happens, start over.
- You must turn off the TV/VCR for several minutes during automatic clock setting. If the clock is not set when you turn on the TV/VCR, repeat the steps for Automatic PBS Channel Selection. If the clock still is not set, set the clock manually.
- You cannot use the AUTO CLOCK feature if you don't receive a PBS channel that carries a time signal in your area. Set the clock manually.

# 16 Setting the Clock (cont'd)

## Manual PBS Channel Selection

1

Press the MENU button to display the pop up menu.

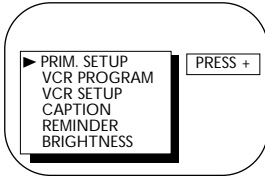

2

Press the PLAY/▲ button or the STOP/▼ button to select PRIM. SETUP. Then, press the F.FWD/+ button.

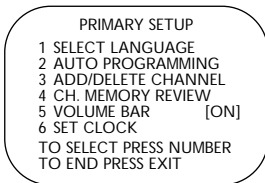

3

Press the Number 6 button to select SET CLOCK.

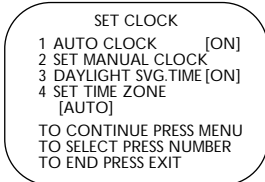

4

If ON appears beside AUTO CLOCK, press the MENU button. If OFF appears beside AUTO CLOCK, press the Number 1 button so that ON appears to the right of AUTO CLOCK, then press the MENU button.

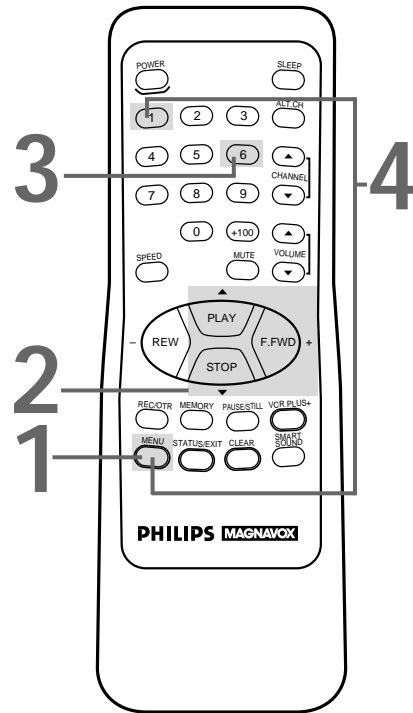
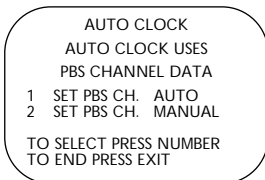



## Setting the Clock (cont'd) 17

# 5

Press the **Number 2** button to select **SET PBS CH. MANUAL**.

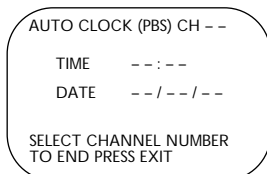

# 6

Use the **Number** buttons to select your PBS station.

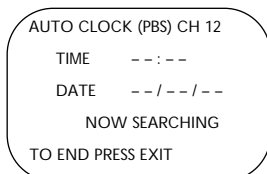

# 7

NOW SEARCHING flashes on the TV/VCR screen.

# 8

When the TV/VCR finds the PBS channel, the time will appear on-screen. Press the **STATUS/EXIT** button.

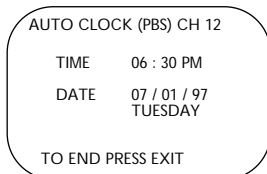

- If **CANNOT FIND CLOCK DATA** flashes on the TV/VCR screen and you know another PBS channel, press the **Number 1** button to select **SELECT NEW PBS CH**. Repeat step 6.
- If **CANNOT FIND CLOCK DATA** flashes on the TV/VCR screen and you do not know another channel, press the **Number 2** button to select **SET PBS CH. AUTO**. The TV/VCR will search for the PBS channel automatically.
  - If the PBS channel is found, the time will appear on-screen.
  - If the PBS channel is not found, you will be prompted to turn off the TV/VCR. Leave it off for several minutes. When you turn on the TV/VCR again, the time will be set.

**7** Wait for the TV/VCR to find the time.

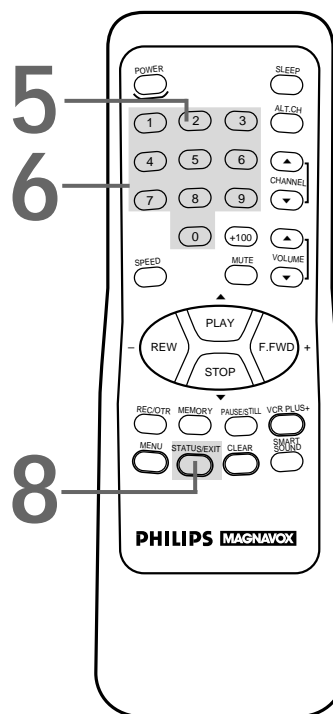

### Helpful Hints

- To make corrections while you are setting the PBS station, press the **CLEAR** button, then enter the correct number.
- If you have an Antenna hookup, you may select channels 2 - 69 at step 6. If you have a cable connection, you may select channels 1 - 125 at step 6. Details about available channels are on pages 10 - 11.
- To display the time, press the **STATUS/EXIT** button. A status display, which includes the time, will appear on the TV/VCR screen. Details are on page 26.

## 18 Daylight-Saving Time

When the Daylight-Saving Time feature is ON, the TV/VCR clock will automatically move forward one hour on the first Sunday in April and move back one hour on the last Sunday in October.

Details are on page 53.

To turn Daylight-Saving Time ON or OFF, follow the steps below.

# 1

Press the MENU button to display the pop up menu.

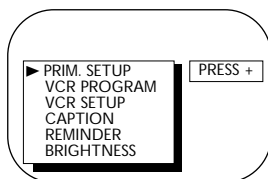

# 2

Press the PLAY/▲ button or the STOP/▼ button to select PRIM. SETUP. Then, press the F.FWD/+ button.

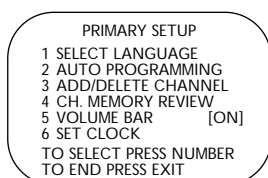

# 3

Press the Number 6 button to select SET CLOCK.

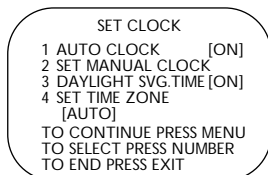

# 4

Press the Number 3 button so that ON or OFF appears beside DAYLIGHT SVG. TIME (Daylight-Saving Time).

# 5

Press the STATUS/EXIT button.

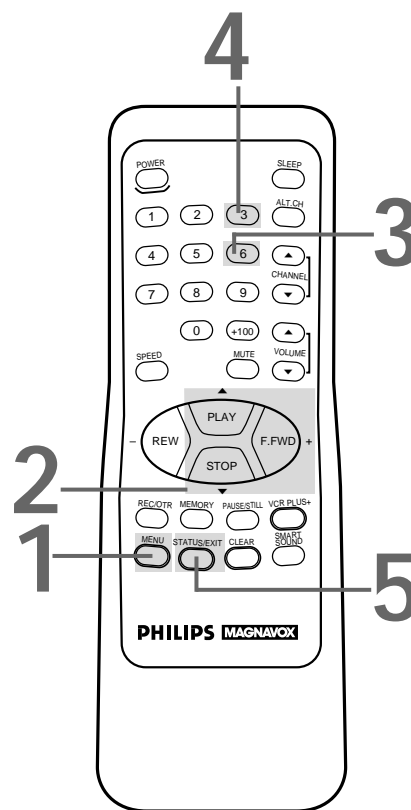

## Time Zone 19

When you set the clock using AUTO CLOCK (either Manual PBS Channel Selection or Automatic PBS Channel Selection), you can specify a time zone in which a local PBS channel is located. That way, the TV/VCR will set the clock according to your time zone.

# 1

Press the **MENU** button to display the pop up menu.

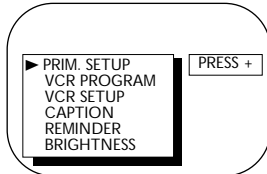

# 2

Press the **PLAY/▲** button or the **STOP/▼** button to select **PRIM. SETUP**. Then, press the **F.FWD/+** button.

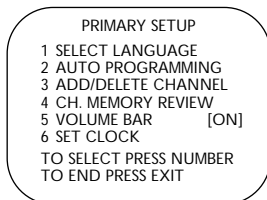

# 3

Press the **Number 6** button to select **SET CLOCK**.

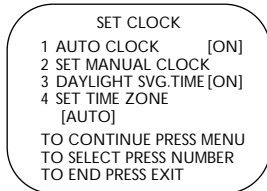

# 4

Press the **Number 4** button to select **SET TIME ZONE**.

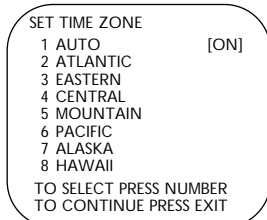

# 5

Find your time zone, then press the **Number** button to select it. **ON** will appear beside the selected time zone.

# 6

Press the **STATUS/EXIT** button twice.

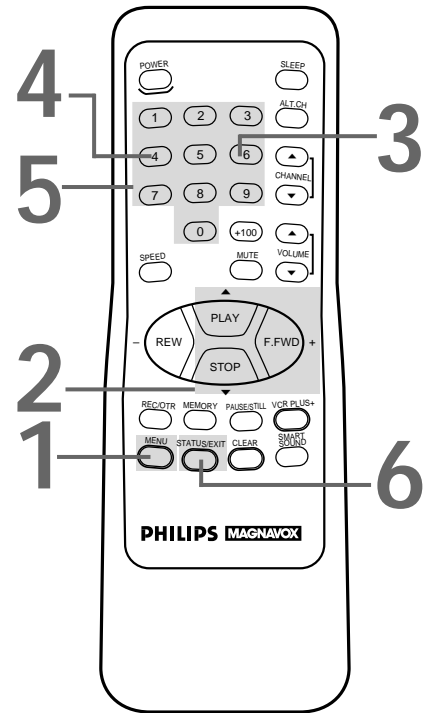

### Helpful Hints

- If you select **AUTO** at step 5, the TV/VCR will set the clock according to the first PBS station it finds.
- You cannot select **TIME ZONE** at step 4 if **AUTO CLOCK** is set to **OFF**.

## 20 Front Panel

### Cassette Compartment

Insert a video cassette tape here.

### Remote Sensor

Receives an infrared signal from your remote control so you can operate the TV/VCR from a distance.

### REC(ord) Light

Appears when a recording, timer recording, or one touch recording is in progress. It flashes when the TV/VCR power is turned off to set a timer recording, or when a recording is paused.

### VIDEO Jack

Connect this jack to the video out jack of a camcorder or a VCR. *Details are on page 31.*

### AUDIO Jack

Connect this jack to the audio out jack of a camcorder or a VCR. *Details are on page 31.*

### POWER Button

Press to turn the power on or off.

### STOP/EJECT Button

Press once to stop the tape. Press again to eject the tape.

### REW(ind) Button

When in Stop mode, press to rewind the tape at high speed. When in Play mode, press to rewind while the picture stays on-screen. *Details are on page 50.*

### PLAY Button

Press to play a tape. Also, press to release Search or Still mode and return to normal playback. *Details are on page 50.*

### F.FWD Button

When in Stop mode, press to fast forward the tape at high speed. When in Play mode, press to fast forward while the picture stays on-screen. *Details are on page 50.*

### REC(ord)/OTR Button

Press once to start a recording. *Details are on page 29.* Or, press three to 18 times to start a one touch recording (an immediate timed recording, 30 minutes to eight hours long) of the channel you are watching. *Details are on page 30.*

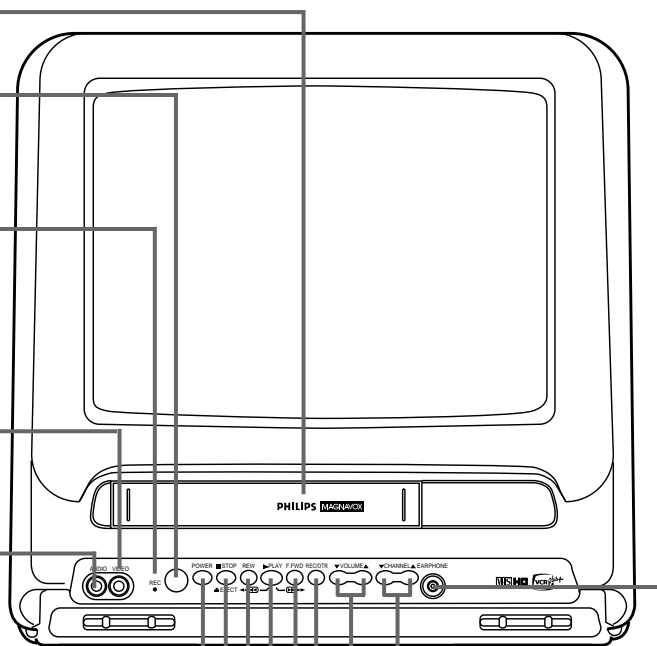

### CHANNEL Up/Down Buttons

Press to scan through the TV/VCR channels. Or, when in Play mode, press to adjust the tracking. *Details are on page 49.* Press the CHANNEL Up button and the VOLUME Down button on the TV/VCR at the same time to display the pop up menu.

### VOLUME Up/Down Buttons

Press to adjust the sound level. Press the CHANNEL Up button and the VOLUME Down button on the TV/VCR at the same time to display the pop up menu.

### EARPHONE Jack

Connect headphones (not supplied) here for personal listening.

## Rear Panel 21

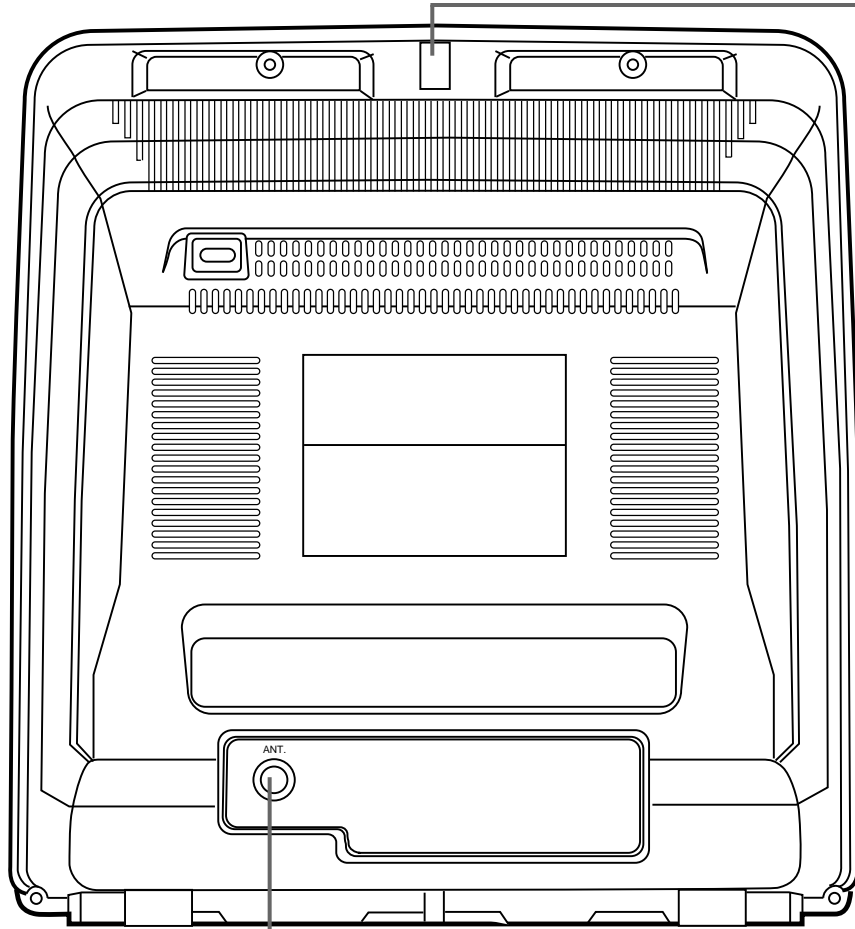

### **ANT(enna) Jack**

Connect your antenna or cable here.  
*Details are on pages six - seven.*

### **Antenna Hole**

Connect the stem of an indoor antenna  
here. *Details are on page six.*

## 22 Remote Control Buttons

### SLEEP Button

Press to set the sleep timer. *Details are on page 41.*

### POWER Button

Press to turn on or off the TV/VCR.

### Number Buttons

Use to select channels and to program TV/VCR functions (such as setting the clock).

#### ● Channels 1 - 9

To select, press 0, then press the channel you want to select. For example, to select channel 7, press 0, 7.

#### ● Channels 100 and above

To select, press the +100 button, then press the last two digits of the channel you want. For example, to select channel 117, press the +100 button, 1, 7.

### (Tape) SPEED Button

Press to select the recording speed (SP, LP, or SLP).

### PLAY/▲ Button

Press to play a tape. *Details are on page 28.* Also, press to release Search or Still mode and return to normal playback. *Details are on page 50.*

Press to select an item in the pop up menu.

### REW(ind)/- Button

When in Stop mode, press to rewind the tape at high speed.

When in Play mode, press to rewind the tape while the picture stays on-screen. *Details are on page 50.*

Press to change a setting of a pop up menu item.

Press to adjust the picture controls. *Details are on pages 24 - 25.*

### REC(ord)/OTR Button

Press once to start a recording. *Details are on page 29.* Or, press three to 18 times to start a one touch recording (an immediate timed recording, 30 minutes to eight hours long) of the channel you are watching. *Details are on page 30.*

### MENU Button

Press to display the pop up menu.

### STATUS/EXIT Button

Press to see the status display. Press again to remove the status display. *Details are on page 26.*

Press to exit the on-screen menu.

### SMART SOUND Button

Press to turn the Smart Sound feature on or off. *Details are on page 44.*

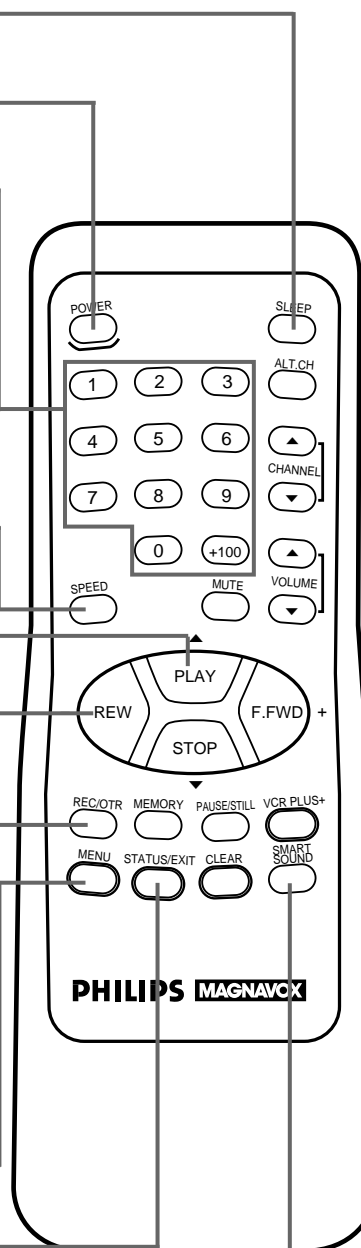

## Remote Control Buttons (cont'd) 23

### ALT. CH (Alternate Channel) Button

Press to return to the TV channel you were viewing immediately before switching to your current channel.

### CHANNEL Up/Down Buttons

Press to scan through the TV/VCR's channels.

### VOLUME Up/Down Buttons

Press to adjust the sound level. If you press the VOLUME Up/Down buttons when the sound is muted, the sound will be restored.

### MUTE Button

Press to eliminate the TV/VCR's sound. Press again to return to the previous volume level.

### F.FWD/+ Button

When in Stop mode, press to fast forward the tape at high speed. During tape playback, press to fast forward while the picture stays on-screen. *Details are on page 50.*

Press to change a setting of a pop up menu item.

Press to adjust the picture controls. *Details are on pages 24 - 25.*

### STOP/▼ Button

Press to stop tape playback or recording.

Press to select an item in the pop up menu.

### PAUSE/STILL Button

In Record mode, press to temporarily stop the recording (pause). Press again to resume recording. *Details are on page 29.* You cannot pause a One Touch Recording that is set for a specific length of time.

During tape playback, press to freeze the picture (still). Each time you press the PAUSE/STILL button, the noise lines will change position on-screen. *Details are on page 50.*

### MEMORY Button

Press to memorize a tape position at which the real time counter was set to 0:00:00. *Details are on page 48.* Or, press to memorize the start and end position on a tape when setting up A-B Repeat Playback. *Details are on pages 46 - 47.*

### CLEAR Button

Press to erase incorrect data when programming TV/VCR functions. Also, press to reset the real time counter. *Details are on page 48.*

### VCR PLUS+ Button

Press to set a Timer Recording with the VCR Plus+ programming system. *Details are on pages 36-39.*

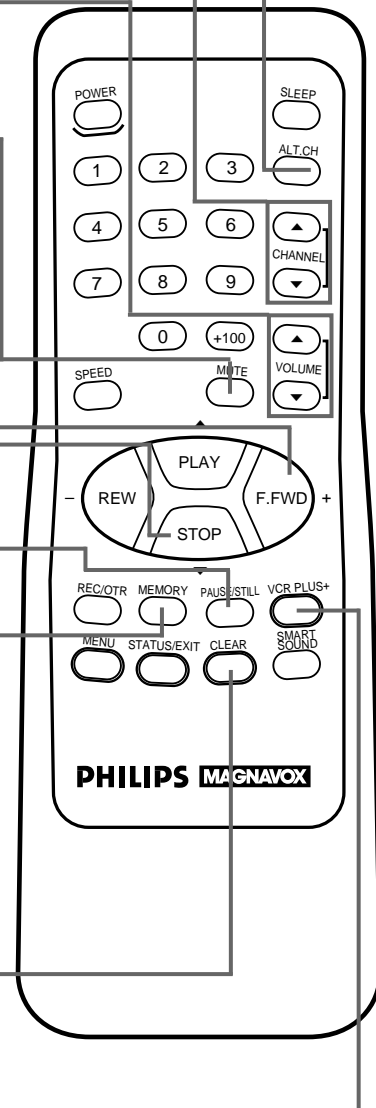

## 24 Adjusting the Picture Controls

Follow these steps to adjust the TV/VCR's brightness, picture, color, tint, and sharpness.

# 1

Press the **MENU** button to display the pop up menu.

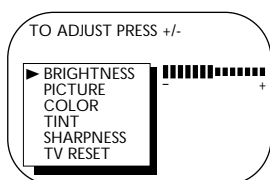

# 2

Press the **PLAY/▲** button or the **STOP/▼** button to select the desired control (BRIGHTNESS, for example).

# 3

Press the **REW(ind)/-** button or the **F.FWD/+** button to adjust the picture control. (Refer to the chart on page 25.)

# 4

When you finish, press the **STATUS/EXIT** button.

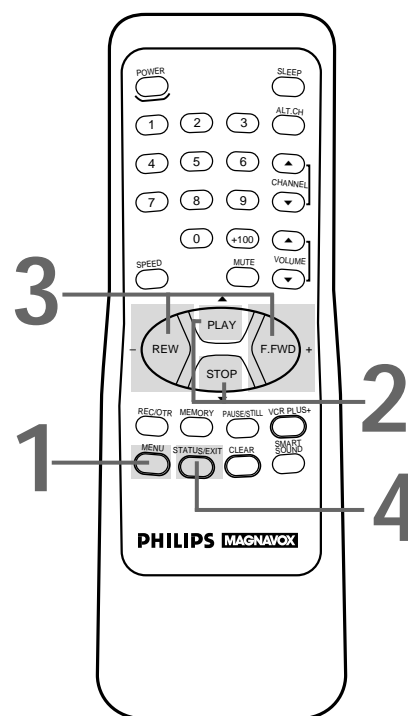

### Helpful Hints

- The on-screen menus shown on page 25 will disappear from the TV/VCR screen if no adjustments are made within 60 seconds.
- The original settings will probably give you the best picture quality.
- To reset the picture controls to the original settings, press the **MENU** button, then press the **PLAY/▲** button or the **STOP/▼** button to select **TV RESET**, then press the **F.FWD/+** button. **TV RESET COMPLETED** will appear on-screen briefly.



## Adjusting the Picture Controls (cont'd) 25

	Decrease	Increase
<b>BRIGHTNESS</b>	decreased brightness	increased brightness
<b>PICTURE</b>	decreased contrast	increased contrast
<b>COLOR</b>	paler	more brilliant
<b>TINT</b>	more purple	more green
<b>SHARPNESS</b>	softer	clearer

Press the REW(ind)/- button to decrease a picture control.  
 Press the F.FWD/+ button to increase a picture control.

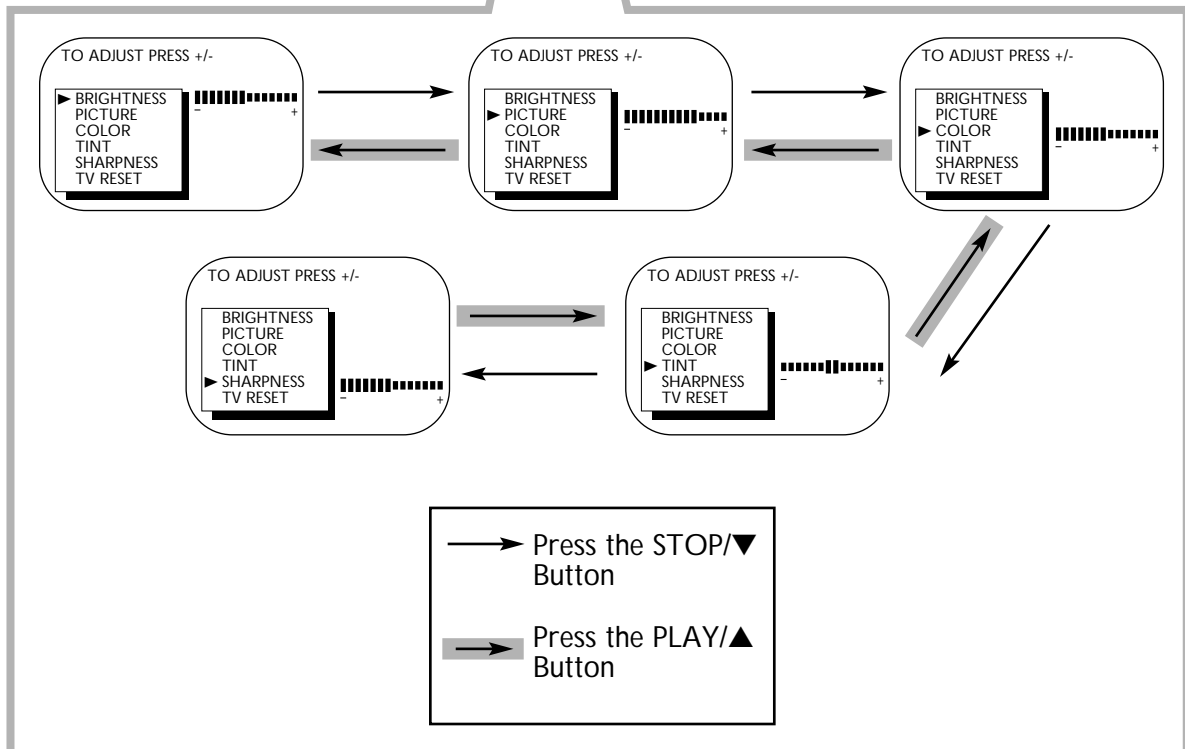
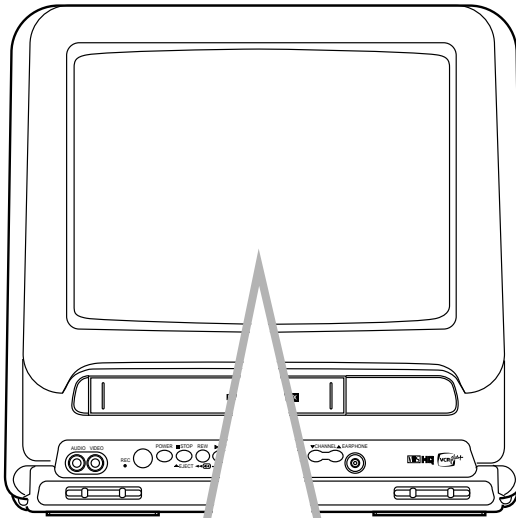

## 26 On-Screen Status Displays

A status display, which includes the current time, channel, and other information (see illustration of the status display at right), will appear when you press the STATUS/EXIT button or certain function buttons. You can bring up the status display at any time by pressing the STATUS/EXIT button. Remove the status display by pressing this button again. The contents of the status display may vary.

### ON MODE:

- Whenever a function button (REW(ind)/-, PLAY/▲, etc.) is pressed, the status display will appear for five seconds.

### COUNTER ONLY MODE:

- When a function button (REW(ind)/-, Play/▲, etc.) is pressed, the status display will appear for five seconds. After five seconds, only the counter will remain on-screen. To remove it, choose ON or OFF in the ON-SCREEN MODE menu. (There is an exception. When you press the STOP/▼ button, the status display will appear for five seconds, then disappear.)

### OFF MODE:

- The status display will not appear when you press a function button. The channel number will appear briefly when you select a channel if channels are programmed.

To choose an ON-SCREEN MODE, follow the steps below.

# 1

Press the MENU button to display the pop up menu.

# 2

Press the PLAY/▲ button or the STOP/▼ button to select VCR SETUP. Then, press the F.FWD/+ button.

# 3

Press the Number 3 button to select ON-SCREEN MODE.

# 4

Press the Number 1 button to select ON, the Number 2 button to select COUNTER ONLY, or the Number 3 button to select OFF. Your selection will appear on-screen.

# 5

Press the STATUS/EXIT button.

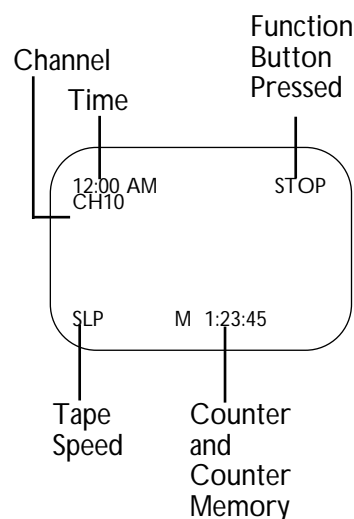

### Helpful Hints

- If the channel you select has no broadcast, the screen will be solid blue. The screen will remain blue until you select an active channel.
- Channel numbers (when tuned) appear on-screen for a few seconds.
- The channel number will remain on-screen at all times (except during tape playback) if REMINDER is set to ON. Details are on page 27.
- You cannot view closed captions of a tape when the TV/VCR is in Counter Only mode. The counter display will replace the closed captioning display on the TV/VCR screen. Details are on pages 42 - 43.

## Reminder 27

The channel number will remain on-screen at all times when you set REMINDER to ON in the pop up menu. The exception is during tape playback, Forward and Reverse Searching, and Still modes, and when closed captioning is selected (CAPTION in the pop up menu).

Set REMINDER to ON or OFF by following the steps below.

# 1

Press the MENU button to display the pop up menu.

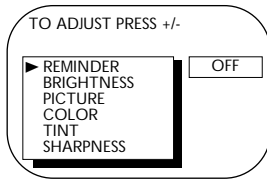

# 2

Press the PLAY/▲ button or the STOP/▼ button to select REMINDER.

# 3

Press the REW(ind)/- button or the F.FWD/+ button to select ON or OFF. Each press of the REW(ind)/- button or the F.FWD/+ button turns REMINDER ON or OFF.

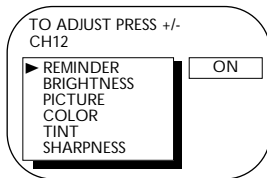

# 4

Press the STATUS/EXIT button.

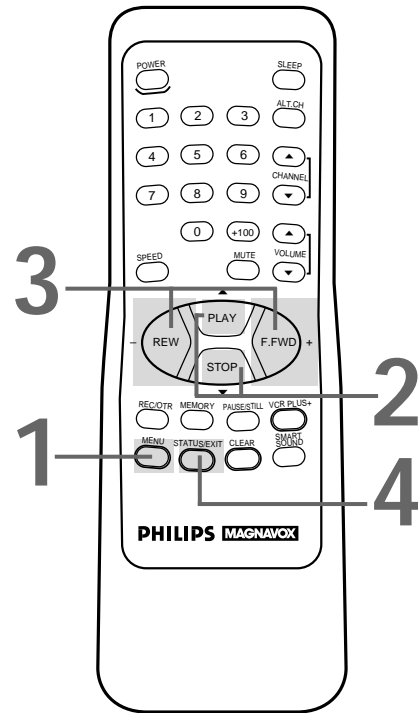

## 28 Playing

Follow the steps below to play a tape.

# 1

**Insert a tape in the TV/VCR.** The power will come on. If the tape's record tab has been removed, playback should start automatically.

# 2

**If playback does not start automatically, press the PLAY/▲ button to start playback.**

# 3

**Press the STOP/▼ button on the remote control or the STOP/EJECT button on the TV/VCR once to stop playback.**

# 4

**Press the REW(ind)/- button to rewind the tape.**

# 5

**When the tape has finished rewinding, press the STOP/EJECT button on the TV/VCR to remove the tape.**

**1** Insert a tape in the TV/VCR.

**5** Press the STOP/EJECT button on the TV/VCR.

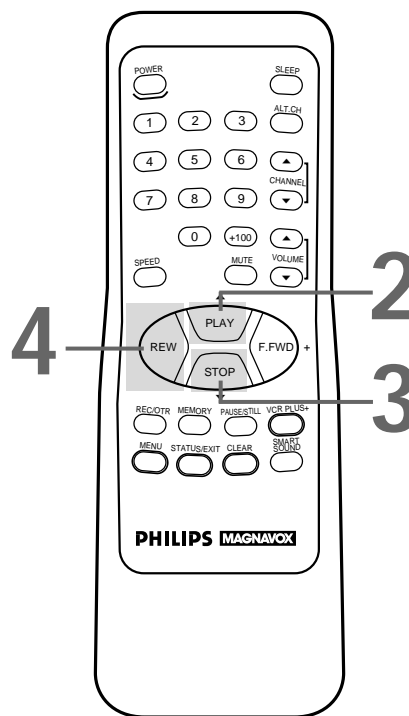

### Helpful Hints

- If the tape you want to play is already in the TV/VCR, turn on the TV/VCR power, then press the PLAY/▲ button.
- Playback features and options are on pages 41 - 50.

Read and follow the steps below to record a TV program.

## 1

Place a tape with its record tab intact (see page five) in the TV/VCR. The power will come on. Or, if the tape is already in the TV/VCR, press the POWER button.

## 2

Press the (Tape) SPEED button until the desired tape speed appears on the TV/VCR screen. Details about tape speed are given below.

## 3

Use the CHANNEL Up/Down buttons or the Number buttons to select the channel to be recorded. (Channels cannot be changed during recording.)

## 4

Press the REC(ord)/OTR button once to start recording. The REC(ord) light will glow.

- If there is not a tape in the TV/VCR, NO CASSETTE flashes on-screen briefly.
- If the tape does not have a record tab, PROTECTED CASSETTE / CANNOT RECORD flashes on-screen briefly. The TV/VCR will eject the tape. Replace it with another tape.

## 5

To pause the recording (for example, during commercials), press the PAUSE/STILL button. The REC(ord) light will flash. To resume recording, press the PAUSE/STILL button again or the REC(ord)/OTR button. The REC(ord) light will glow.

## 6

To stop recording, press the STOP/▼ button.

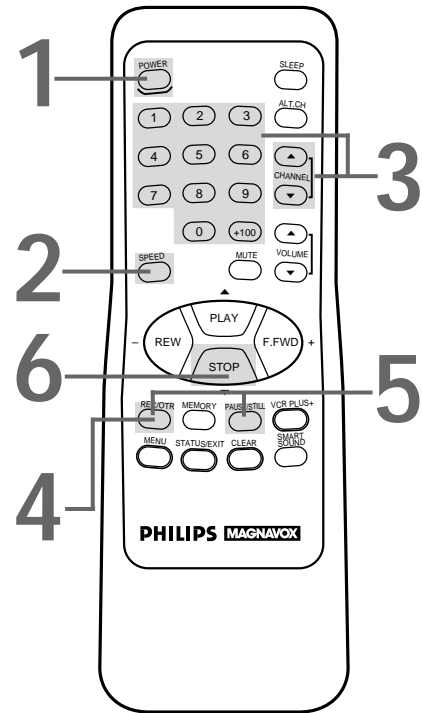

### Tape Speeds

This chart shows the recording/playback time for three types of video cassettes (T160, T120, and T60). There are three playback speeds: SP, LP, and SLP. During playback, the TV/VCR selects the tape speed automatically. When recording, you can change the tape speed using the (Tape) SPEED button (see page 22).

Tape Speed	Maximum Record/Playback Time			
	Type	T160	T120	T60
SP (Standard Play)		2 hrs. 40 mins.	2 hrs.	1 hr.
LP (Long Play)		5 hrs. 20 mins.	4 hrs.	2 hrs.
SLP (Super Long Play)		8 hrs.	6 hrs.	3 hrs.

### Helpful Hints

- Recording options are on pages 30 - 39.
- You cannot record if the TV/VCR is in Record Defeat mode (REC DEFEATED will flash on-screen). Details are on page 40.
- If you pause a recording for more than five minutes, the TV/VCR will switch to Stop mode automatically to protect the video cassette tape from damage.
- You can change the tape speed with the (Tape) SPEED button while a recording is in progress, but some distortion may appear on the tape.

## 30 One Touch Recording

The one touch recording (OTR) function allows you to program an immediate timed recording from 30 minutes to eight hours long without setting the timer.

Before you begin, make sure:

- Channels are programmed.
- There is a tape in the TV/VCR. The record tab must be intact.

# 1

Use the **CHANNEL Up/Down** buttons or the **Number** buttons to select the channel you want to record.

# 2

Press the **(Tape) SPEED** button until the desired recording speed (**SP**, **LP**, or **SLP**) appears on-screen. Details are on page 29.

# 3

Press the **REC(ord)/OTR** button repeatedly, until the desired recording length appears in the upper right corner of the screen. Recording will begin immediately. The **REC(ord)** light will appear.

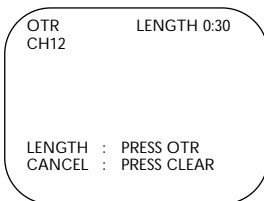

# 4

To stop an OTR before recording is finished, press the **STOP/EJECT** button on the TV/VCR.

Or, press the **REC(ord)/OTR** button, then press the **CLEAR** button, then press the **STOP/▼** button on the remote control.

# 4

Press the **STOP/EJECT** button on the TV/VCR to stop the OTR.

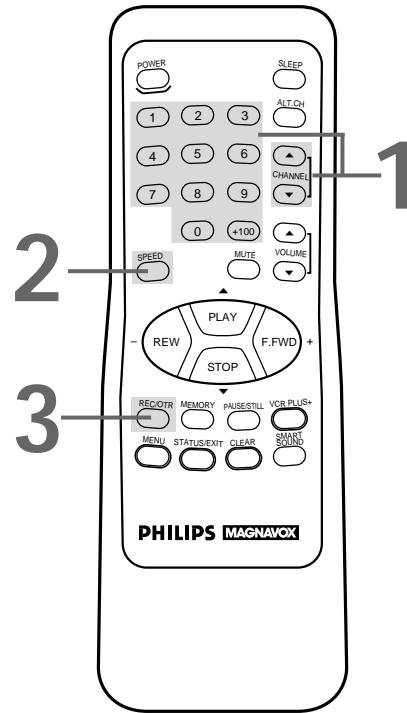

### Helpful Hints

- To check the time remaining for an OTR after the OTR has been set, press the **STATUS/EXIT** button.
- To change the recording length while an OTR is in progress, press the **REC(ord)/OTR** button until the desired recording length appears on-screen.
- You can not pause an OTR.
- To cancel an OTR, but continue recording, press the **REC(ord)/OTR** button, then press the **CLEAR** button.
- You cannot record if the TV/VCR is in Record Defeat mode. Details are on page 40.
- You can change the tape speed with the **(Tape) SPEED** button while a recording is in progress, but some distortion may appear on the tape.
- If the end of the tape is reached during an OTR, recording will stop. The TV/VCR will eject the tape and shut itself off. The **REC(ord)** light may flash.

## Rerecording (Tape Duplication) 31

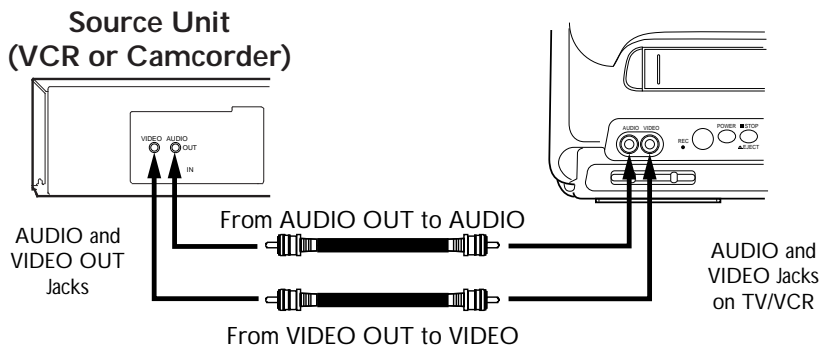

1

Make the connections shown above, using audio and video cables.

2

The source unit (VCR or camcorder) will play your tape. **Insert a prerecorded tape in the source unit.** If playback begins, press the STOP button on the unit.

3

The TV/VCR will record your tape. **Insert a blank tape in the TV/VCR.** Make sure the tape's record tab is intact. The TV/VCR will turn on automatically.

4

Point the remote control at the TV/VCR. Press Number buttons 0, 0 so that A/V IN appears on-screen.

5

Point the remote control at the TV/VCR. Press the (Tape) SPEED button until the desired tape speed (SP, LP, or SLP) appears on-screen.

6

Press the PLAY button on the source unit and the REC(ord)/OTR button on your TV/VCR at the same time. Copying will begin.

7

To stop copying, press the STOP/EJECT button on the TV/VCR, then stop the tape on the source unit (VCR or camcorder).

### Helpful Hints

- Unauthorized recording of copyrighted television programs, video tapes, or other materials may infringe on the rights of copyright owners and violate copyright laws.
- Different brands of equipment may operate differently.
- Make sure all connections are secure. Otherwise, you may not record both picture and sound.
- Audio and video cables are not included.

## 32 Timer Recording

Follow the steps below to program the TV/VCR to record TV programs while you're away from home. You can program up to eight timer recordings. For each one, the TV/VCR will turn itself on, record, and turn itself off automatically. Before you begin make sure:

- The clock has been set. If not, CLOCK MUST BE SET appears.
- Channels are programmed.
- There is a tape in the TV/VCR (make sure the tape's record tab is intact and the tape is long enough to record the program).

**Complete each step within 60 seconds of completing the previous step. If you don't, you may start again at step 1.**

# 1

Press the **MENU** button to display the pop up menu.

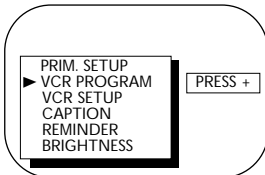

# 2

Press the **PLAY/▲** button or the **STOP/▼** button to select **VCR PROGRAM**, then press the **F.FWD/+** button.

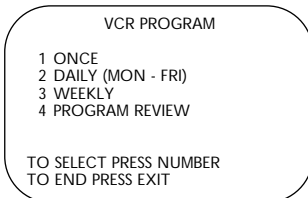

# 3

Select a once, daily or weekly recording.

- Press the Number 1 button to select **ONCE**. The TV/VCR will record a TV program on any day you choose, up to 12 months away.
- Press the Number 2 button to select **DAILY**. The TV/VCR will record from Monday through Friday – starting at the same time and recording for the same length of time every day.
- Press the Number 3 button to select **WEEKLY**. The TV/VCR will record on the same day, at the same time, and for the same length of time every week.

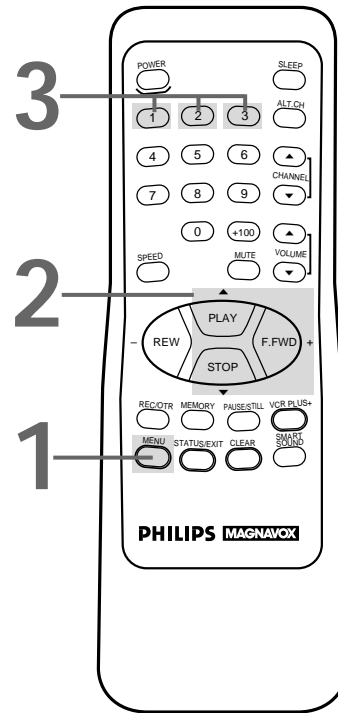

### Helpful Hints

- If the power fails, programmed timer recordings will be lost.
- You cannot set a timer recording if the TV/VCR is in Record Defeat mode. To set the Record Defeat mode to OFF, see page 40.



## 4

Use the **Number buttons (1 - 8)** to select a position in which to store the timer recording. Flashing numbers indicate an open position (one in which a timer recording has not yet been stored).

*NOTE: If you select a number that has already been used to store a timer recording, PREVIOUSLY SET PROGRAM will appear on-screen for a few seconds. Then information about the program in that position will appear on-screen. If this happens, press the STATUS/EXIT button. Then use the Number buttons to select another position.*

## 5

- Enter the channel of the TV program you want to record (you must enter a 0 before all single digit channels).
- If you are recording from line input, press 0, 0. A/V IN will appear on-screen.
- If you are recording using a Cable Box, enter the Cable Box output channel (03 or 04). Be sure to select the channel at the Cable Box and leave the Cable Box on for the timer recording.

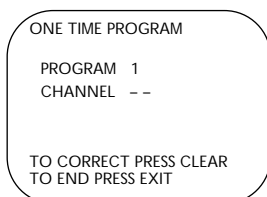

## 6

Press two **Number buttons** for the hour(s) you want the recording to begin. Press two **Number buttons** for the minute(s) you want the recording to begin. Press **1** for **AM** or **2** for **PM**. For example, for 9:30 PM, press 09, 30, 2.

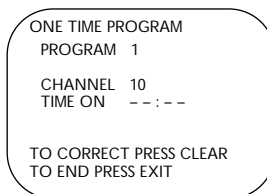

## 7

Follow the instructions in step 6 to set the recording's stop time. (AM or PM will be set automatically.)

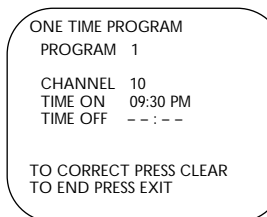

## 4-7

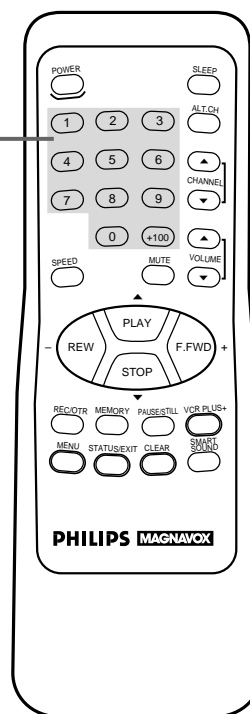

### Helpful Hints

- If the numbers entered do not match the TV/VCR's internal calendar, the entry will be rejected and a question mark (?) will appear on the TV/VCR screen.
- To make corrections while you are programming a timer recording, press the CLEAR button until the cursor is flashing on the item you want to change. Then enter the correct information.

## 34 Timer Recording (cont'd)

# 8

Press the **Number 1** button to record in SP speed, press the **Number 2** button to record in LP speed, or press the **Number 3** button to record in SLP speed. Details about tape speed are on page 29. You cannot use the (Tape) SPEED button at this time.

```

ONE TIME PROGRAM
PROGRAM 1

CHANNEL 10
TIME ON 09:30 PM
TIME OFF 11:00 PM
REC SPEED SLP
SP=1 LP=2 SLP=3

TO CORRECT PRESS CLEAR
TO END PRESS EXIT
    
```

# 9

Press two **Number** buttons for the month and two **Number** buttons for the day you want the program to record. For example, for July 10, 1997, press 07, 10. The day of the week and the year will be displayed automatically (you cannot program the TV/VCR to record more than one year in advance).

```

ONE TIME PROGRAM
PROGRAM 1

CHANNEL 10
TIME ON 09:30 PM
TIME OFF 11:00 PM
REC SPEED SLP
START DATE 07/10/97
THURSDAY

TO CORRECT PRESS CLEAR
TO END PRESS EXIT
    
```

# 10

Press the **STATUS/EXIT** button. PROGRAM WAS COMPLETED / PLEASE TURN OFF FOR TIMER RECORDING will appear on-screen.

- If there is not a tape in the TV/VCR, PLEASE INSERT CASSETTE also appears on-screen.
- If there is a tape without a record tab in the TV/VCR, PLEASE REMOVE CASSETTE also appears on-screen. If this happens, insert a different tape.
- If PROGRAM NOT COMPLETED appears, start again at step 1. In five seconds the on-screen message will disappear.

# 11

Turn off the **TV/VCR power**. The REC(ord) light will flash. If you forget to turn off the TV/VCR, PLEASE TURN OFF FOR TIMER RECORDING appears on the TV/VCR screen two minutes before a timer recording starts.

**The TV/VCR must be off for a timer recording to take place!**  
**Make sure there is a tape in the TV/VCR.**

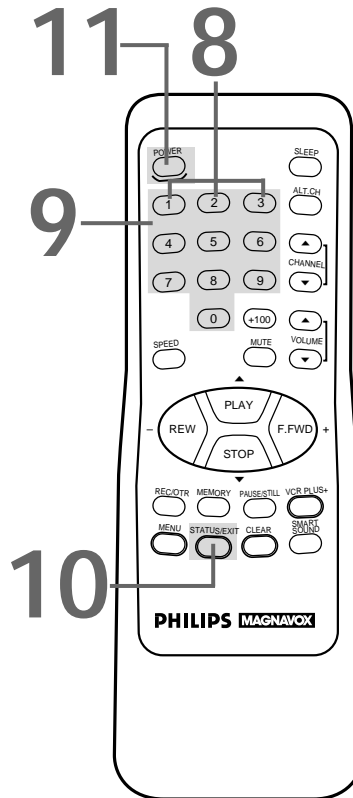

### Helpful Hints

- PROGRAM NOT COMPLETED / CLASH may appear on-screen when you finish setting a timer recording. This means that the timer recording you just programmed and another timer recording overlap, and thus the current timer recording will not be carried out.
- To stop a started timer recording, press the STOP/EJECT button on the TV/VCR. Please see page 52 for more Helpful Hints.

### Checking or Clearing Timer Recordings

**1**

With the TV/VCR on, press the MENU button.

**2**

Press the PLAY/▲ button or the STOP/▼ button to select VCR PROGRAM, then press the F.FWD/+ button.

**3**

Press the Number 4 button to select PROGRAM REVIEW. The timer recording information for the program in the lowest numbered position will appear on-screen. If no timer recordings are programmed, nothing will happen when you press the Number 4 button.

**4**

Press the Number 1 button to display information about the next programmed timer recording. (If you do not press a button within 10 seconds, information about the next programmed timer recording will appear.) This will continue until all positions have been displayed. Then, the menu will disappear. You can exit the Program Review at any time by pressing the STATUS/EXIT button.

**5**

To cancel the timer recording displayed, press the CLEAR button. Then, press the STATUS/EXIT button.

**6**

Repeat steps 1 - 4 to make sure you have cleared the correct position.

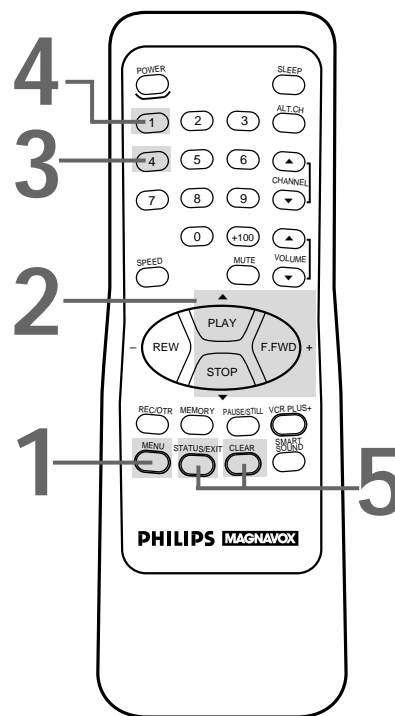



## Setting Up the VCR Plus+ Programming System (cont'd) 37

# 2

Now, compare the channel numbers you have written in the VCR PLUS+ CH. and CABLE/TV CH. columns. You'll notice that some stations have VCR Plus+ and Cable/TV channel numbers that are the same, and other stations have channel numbers that do not match. Where the channel numbers DO NOT match, you must tell the TV/VCR the VCR Plus+ and Cable/TV channel numbers according to the following steps.

- Make each entry within 60 seconds of the previous entry.

# 3

Press the MENU button to display the pop up menu.

# 4

Press the PLAY/▲ button or the STOP/▼ button to select VCR SETUP, then press the F.FWD/+ button.

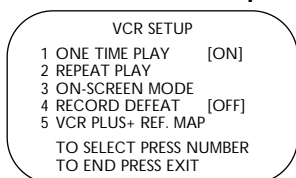

# 5

Press the Number 5 button to select VCR PLUS+ REF. MAP.

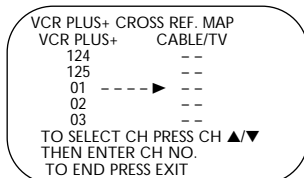

# 6

Look at the lists you filled in on page 36. For stations whose VCR Plus+ and Cable/TV channels do not match, press the CHANNEL (Up/Down) buttons until the arrow is beside the VCR Plus+ channel you need. Then, press the Number buttons to enter the corresponding Cable/TV channel from your list. (Enter a "0" before single-digit channels.) Continue this process until you have entered all the stations on your list.

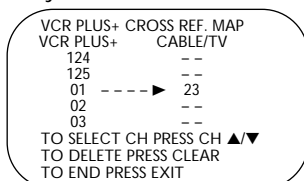

# 7

Press the STATUS/EXIT button to exit.

# 2

Examine the lists on page 36.

# 6

# 5

# 4

# 3

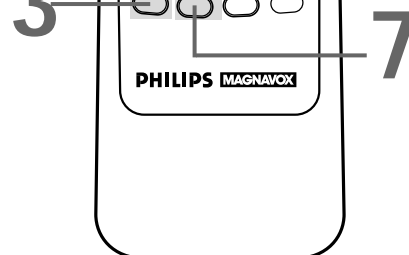

### Helpful Hints

- To correct a Cable/TV channel number, repeat the steps on this page.
- To clear a Cable/TV channel number, repeat steps 3-5 on this page. Then, press the CHANNEL (Up/Down) buttons to select it. Then press the CLEAR button. Press the STATUS/EXIT button to exit.
- Always enter a "0" before single-digit channels.
- To select line input for the Cable/TV channel, press 0,0. A/V IN will appear on-screen.

## 38 Timer Recording With the VCR Plus+ Programming System

Follow the steps below to program a timer recording using the PlusCode programming numbers in your TV guide. Before you begin, make sure:

- The clock has been set. If not, CLOCK MUST BE SET appears.
- Channels are programmed.
- There is a tape in the TV/VCR (make sure the tape's record tab is intact and the tape is long enough to record the program).
- You have completed the steps on pages 36-37.

**Complete each step within 60 seconds of completing the previous step. If you don't, you may return to step 1.**

# 1

Press the **VCR PLUS+** button on the remote control. The on-screen display shown below will appear.

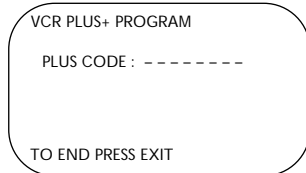

# 2

Press the **Number** buttons to enter the **PlusCode programming number** of the program you wish to record (this number is different for every program, and it can be four to eight digits long). **Finally, press the VCR PLUS+ button.**

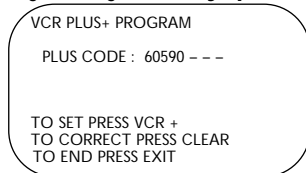

# 3

To record the program once, press the **Number 1** button to select **ONCE**. To record the same program every day from Monday through Friday, press the **Number 2** button to select **DAILY**. To record the same program every week on the same day (such as every Saturday), press the **Number 3** button to select **WEEKLY**.

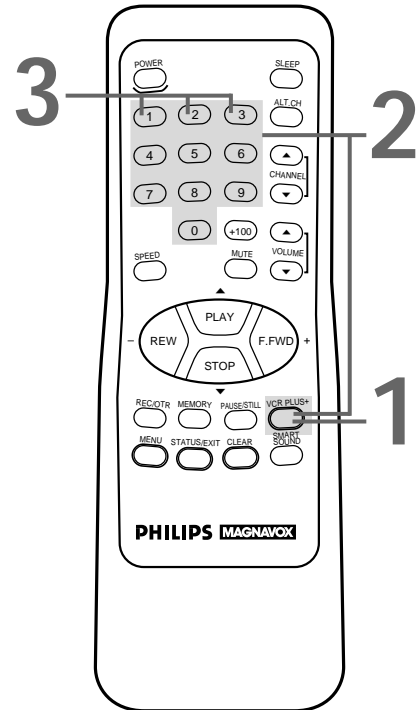
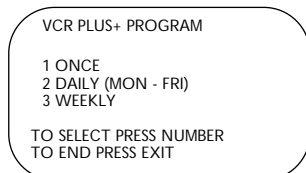

### Helpful Hints

- If the power fails, programmed timer recordings will be lost.
- You cannot set a timer recording if the TV/VCR is in Record Defeat mode. To set the Record Defeat mode to OFF, see page 40.
- If **CODE ERROR** flashes after you enter the PlusCode programming number and press the **VCR PLUS+** button, the number you entered was incorrect (for example, too short). If this happens, enter the correct number.
- **CLASH** may flash on the screen after you complete step 2. This means that the timer recording you just programmed and another timer recording overlap, and thus the current timer recording will not be carried out.

## Timer Recording With the VCR Plus+ Programming System (cont'd) 39

# 4

Press the **Number 1** button to record in SP speed, the **Number 2** button to record in LP speed, or the **Number 3** button to record in SLP speed. Your selection will appear to the right of REC SPEED on-screen, although SP=1 LP=2 SLP=3 will continue to flash. For details about tape speed, see pages 29 and 51. You cannot use the (Tape) SPEED button at this time.

ONE TIME PROGRAM		
PROGRAM	1	
CHANNEL	09	
TIME ON	10:30 PM	
TIME OFF	11:30 PM	
REC SPEED	SLP	
SP=1	LP=2	SLP=3
START DATE	10/10/97	
	FRIDAY	
TO END PRESS EXIT		

# 5

Press the **STATUS/EXIT** button. PROGRAM WAS COMPLETED / PLEASE TURN OFF FOR TIMER RECORDING will appear on-screen.

- If there is not a tape in the TV/VCR, PLEASE INSERT CASSETTE also appears on-screen.
- If there is a tape without a record tab in the TV/VCR, PLEASE REMOVE CASSETTE also appears on-screen. If this happens, insert a different tape.

# 6

Turn off the **TV/VCR power**. The REC(ord) light will flash. If you forget to turn off the TV/VCR, PLEASE TURN OFF FOR TIMER RECORDING appears on the TV/VCR screen two minutes before a timer recording starts.

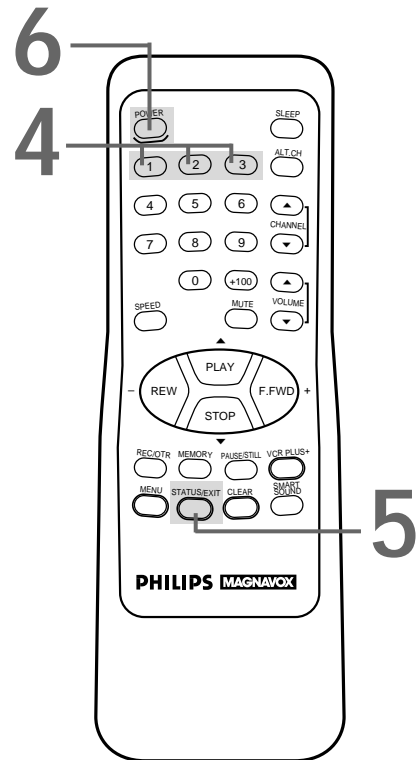

**The TV/VCR must be off for a timer recording to take place! Make sure there is a tape in the TV/VCR.**

### Helpful Hints

- To exit the VCR Plus+ programming system at any time, press the STATUS/EXIT button. The display will disappear from the screen.
- To stop a started timer recording, press the STOP/EJECT button on the TV/VCR.

# 40 Record Defeat

## Record Defeat

Follow the steps below to prevent accidental recording.

# 1

Press the MENU button to display the pop up menu.

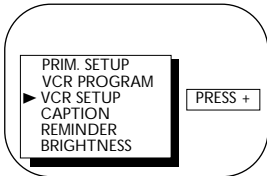

# 2

Press the PLAY/▲ button or the STOP/▼ button to select VCR SETUP, then press the F.FWD/+ button.

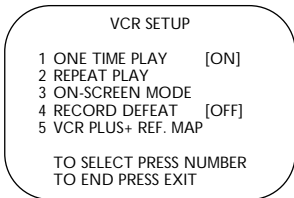

# 3

Press the Number 4 button so that ON appears to the right of RECORD DEFEAT.

# 4

Press the STATUS/EXIT button.

# 5

Now, REC DEFEATED will flash on-screen when you press the REC(ord)/OTR button.

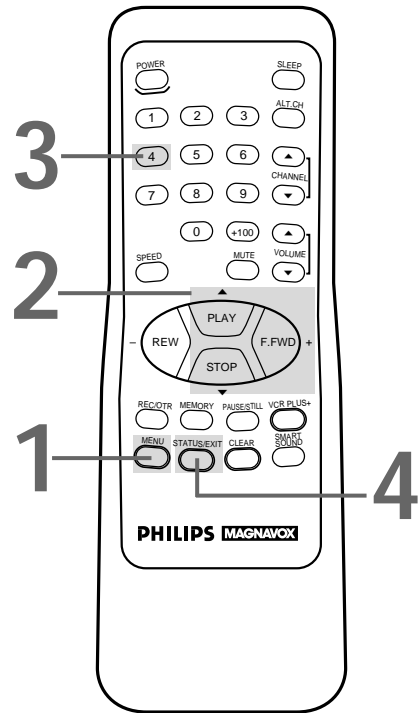
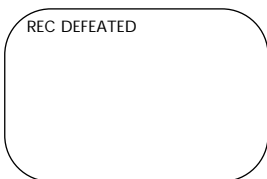

### Helpful Hints

- If you put the TV/VCR in Record Defeat mode after a timer recording has been programmed, the timer recording will not be carried out.
- If you put the TV/VCR in Record Defeat mode, then try to program a timer recording, you will not be able to program a timer recording. VCR PROGRAM cannot be selected from the pop up menu.
- To take the TV/VCR out of Record Defeat mode, repeat steps 1 - 2 above. At step 3, press the Number 4 button so that OFF appears to the right of RECORD DEFEAT on-screen. Press the STATUS/EXIT button.



## Setting the Sleep Timer 41

Use the sleep timer to program the TV/VCR to shut off in a certain amount of time.

# 1

**Press the SLEEP button.** The sleep timer display will appear on-screen. (You can not set the sleep timer during a recording.)

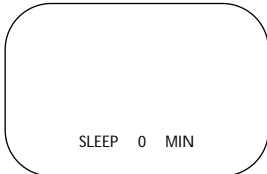

# 2

**Within five seconds, press the SLEEP button repeatedly to select 30 minutes, 60 minutes, 90 minutes, or 120 minutes.** In a few seconds, the display will disappear. Then the TV/VCR will shut itself off after the specified amount of time. One minute before the TV/VCR shuts itself off, the seconds will count down on-screen.

GOOD NIGHT appears on the TV/VCR screen 10 seconds before the TV/VCR shuts itself off.

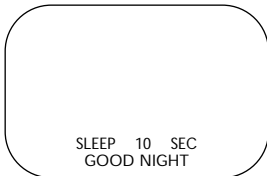

- To see how much time remains until the TV/VCR shuts itself off, press the SLEEP button once. The time remaining will appear on-screen briefly. You cannot do this during a recording.
- To cancel a sleep timer setting, press the SLEEP button until 0 MIN appears on-screen. The on-screen display will disappear in a few seconds. You cannot cancel it during a recording.

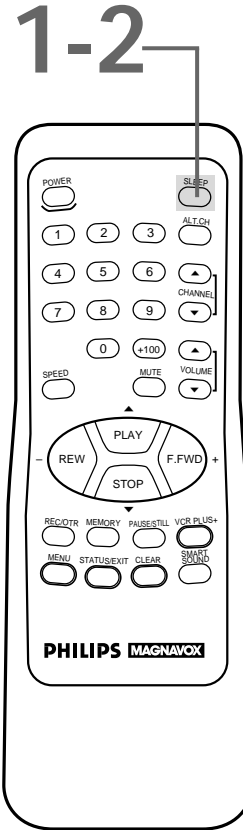

### Helpful Hints

- You can start a recording after the sleep timer is set. If the recording finishes before the TV/VCR shuts itself off, the TV/VCR will shut itself off as programmed with the sleep timer. If a recording is in progress, the TV/VCR will not shut itself off until recording stops.
- A timer recording will not begin until after the TV/VCR shuts itself off. Two minutes before a timer recording starts, PLEASE TURN OFF FOR TIMER RECORDING flashes on-screen. If you see this message, turn off the TV/VCR.
- If the power fails, you might lose the sleep timer setting.

## 42 Closed Captioning

When you watch a program that is being broadcast with closed captioning, you can access on-screen boxes containing the program's dialogue (for example, what a character is saying), dialogue in a foreign language, or information (such as a channel guide, schedule, or announcements). Follow the steps below to select closed captioning.

Not all TV programs and commercials are broadcast with closed captioning. Similarly, all types of closed captioning (second language, full-screen text, etc.) are not always broadcast. If closed captioning is not broadcast, you cannot receive it. This does not indicate a problem with the TV/VCR. Refer to your area's TV program listings for the shows offered with closed captioning.

1

Press the **MENU** button to display the pop up menu.

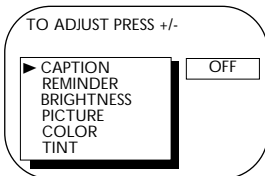

2

Press the **PLAY/▲** button or the **STOP/▼** button to select **CAPTION**.

3

Press the **REW(ind)/-** button or the **F.FWD/+** button to select your desired mode.

The selected closed captioning mode will appear to the right of **CAPTION** on-screen.

- **CAPTION1** displays standard closed captioning (what a character is saying).
- **CAPTION2** displays foreign language closed captioning (foreign language words showing what a character is saying).
- **TEXT1** and **TEXT2** display half screen text (such as a channel guide, schedule, or announcement).
- **OFF** turns closed captioning off. Captions will not appear on-screen.

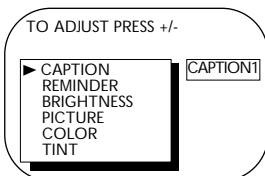

**Example:**  
**CAPTION1**  
**Menu**  
**Screen**

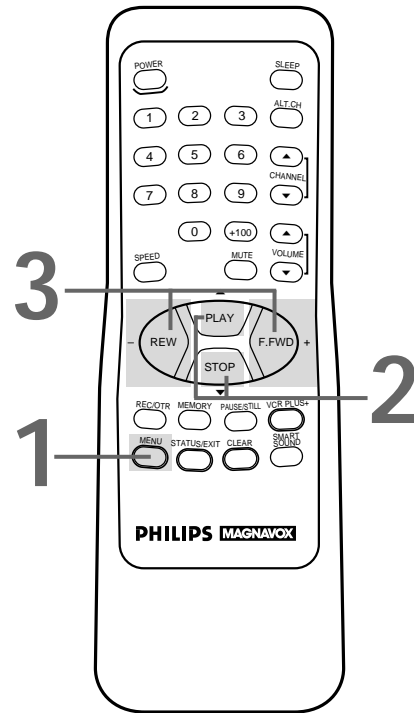

# 4

Press the **STATUS/EXIT** button. The type of closed captioning you selected at step 3 will appear on-screen. (If it does not, see Helpful Hints below. The program must be broadcast with closed captioning.)

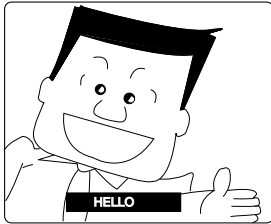

Standard Closed Captioning

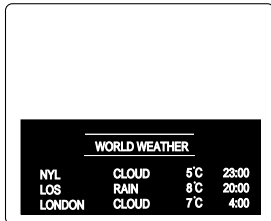

Text Screen

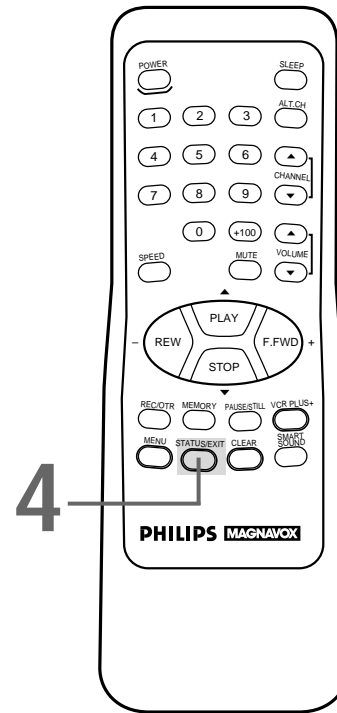

### Helpful Hints

- You cannot view closed captioning of a tape when the TV/VCR is in Counter Only mode. Details are on page 26.
- Abbreviations, symbols, and other grammatical shortcuts are often used in order to keep pace with the on-screen action. This does not indicate a problem with the TV/VCR.
- To cancel closed captioning, follow steps 1 - 2 on page 42. At step 3, press the REW(ind)/- button or the F.FWD/+ button to select OFF. Press the STATUS/EXIT button.
- When you change channels, the closed captioning may be delayed for a few seconds.
- When you adjust the volume or mute the volume, closed captioning may be delayed for a few seconds.

## 44 Volume Bar / Smart Sound

### Volume Bar

Usually, the volume bar appears when you press the VOLUME Up/Down buttons. If you do not need it, set the VOLUME BAR to OFF position. For example, when you watch a program that is being broadcast with closed captioning, you may choose to set the VOLUME BAR to OFF position so the captions can remain on-screen. The captions will remain on-screen even when you press the VOLUME Up/Down buttons or the MUTE button.

1

Press the MENU button to display the pop up menu.

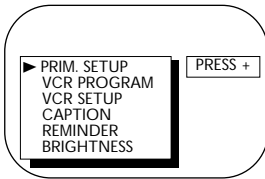

2

Press the PLAY/▲ button or the STOP/▼ button to select PRIM. SETUP. Then, press the F.FWD/+ button.

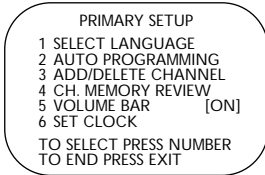

3

Press the Number 5 button so that OFF appears to the right of VOLUME BAR. Each press of the Number 5 button will turn the VOLUME BAR ON or OFF.

4

Press the STATUS/EXIT button.

### Smart Sound

The Smart Sound feature stabilizes the TV/VCR volume. For example, when Smart Sound is turned On, the volume will not increase suddenly during commercials or loud segments of programming. The volume will stay at the same level.

1

Press the SMART SOUND button on the remote control to select ON (or OFF). The on-screen display shown below will appear for 10 seconds.

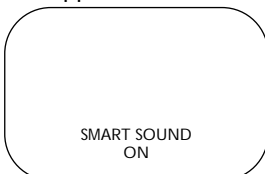

To turn Volume Bar On or Off ...

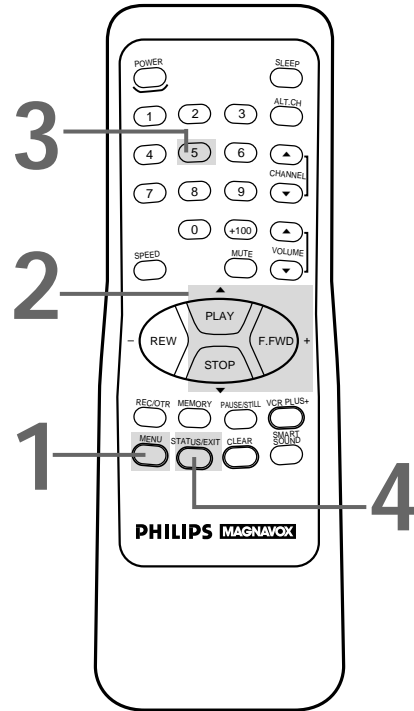

To turn Smart Sound On or Off ...

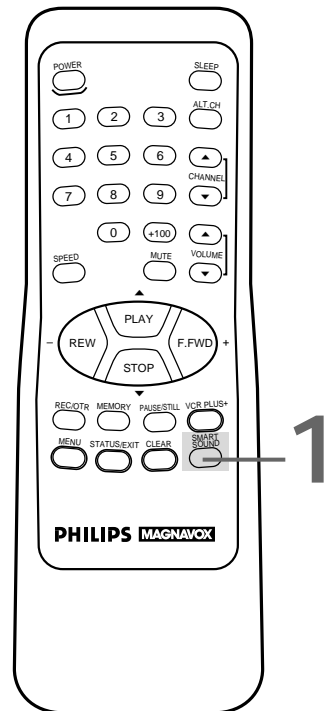

## Repeat Playback 45

Follow the steps below to program the TV/VCR to play a tape over and over.

# 1

Press the **MENU** button to display the pop up menu.

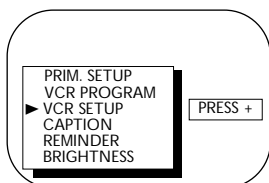

# 2

Press the **PLAY/▲** button or the **STOP/▼** button to select **VCR SETUP**, then press the **F.FWD/+** button.

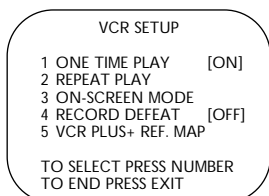

# 3

Press the **Number 2** button so that **ON** appears to the right of **REPEAT PLAY**.

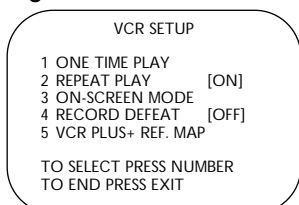

# 4

Press the **STATUS/EXIT** button. Now, when a tape has finished playing, the TV/VCR will rewind it and start playback again. (TV programming will appear while the tape is rewinding.)

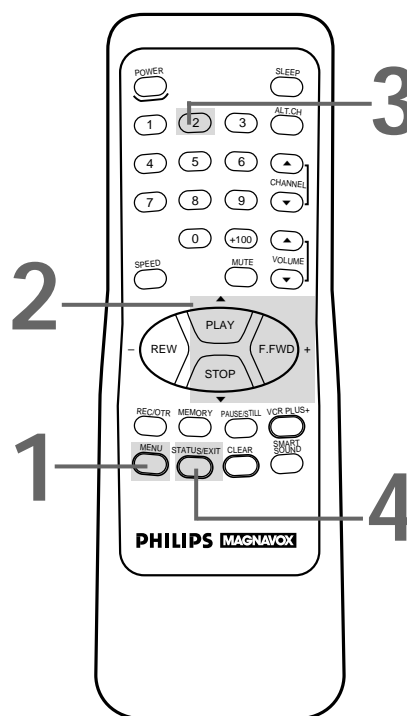

### Helpful Hints

- The TV/VCR will stay in Repeat Play mode until you select ONE TIME PLAY mode, even if the TV/VCR is turned off. To exit Repeat Play mode, follow steps 1 and 2 above. At step 3, press the Number 1 button so that ON appears to the right of ONE TIME PLAY. Press the STATUS/EXIT button.
- The time counter memory will not function during Repeat Play mode.

## 46 A - B Repeat Playback

Follow the steps below to program the TV/VCR to play the material between two specified points (A and B) on a tape over and over again.

# 1

Insert a tape in the TV/VCR.

# 2

Press the MENU button to display the pop up menu.

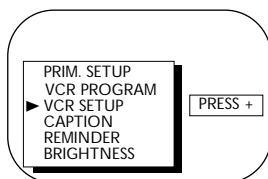

# 3

Press the PLAY/▲ button or the STOP/▼ button to select VCR SETUP, then press the F.FWD/+ button.

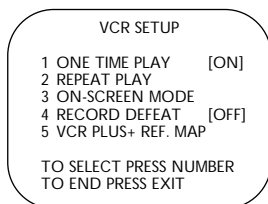

# 4

Press the Number 2 button repeatedly so that A-B appears to the right of REPEAT PLAY.

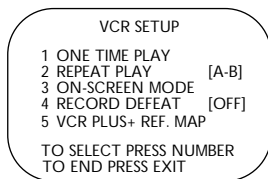

# 1

Insert a tape in the TV/VCR.

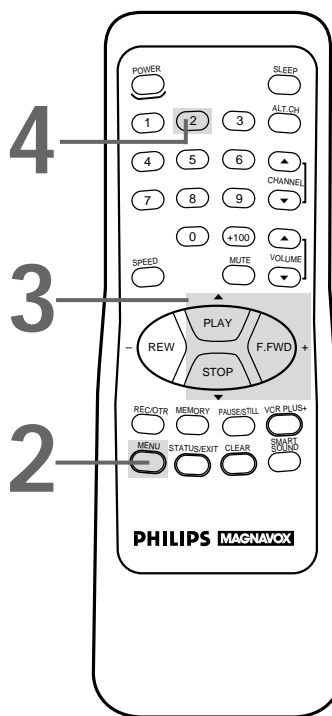

### Helpful Hints

- To cancel A-B Repeat Play mode, follow steps 2 - 3. At step 4, press the Number 1 button so that ON appears to the right of ONE TIME PLAY. Press the STATUS/EXIT button.
- The end position (B) must be later on the tape than the start position (A).

## A - B Repeat Playback (cont'd) 47

5

Press the **STATUS/EXIT** button to remove the display. A-B REPEAT will appear on-screen. Beneath it, the letter A will flash beside the tape counter.

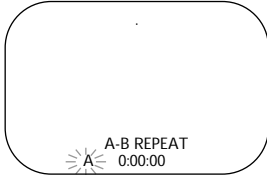

6

Play, fast forward, or rewind the tape to the position at which you want to begin playback. Stop the tape, then press the **MEMORY** button to set the start position (A). The flashing A will become a flashing B.

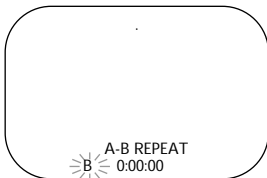

7

Play or fast forward the tape to the position at which you want playback to end. Stop the tape, then press the **MEMORY** button to set the end position (B).

- The length of time between the start position (A) and the end position (B) must be at least three minutes.

8

The TV/VCR will immediately rewind the tape to the start position (A) and repeat playback to the end position (B) over and over.

(TV programming will appear while the tape is rewinding.)

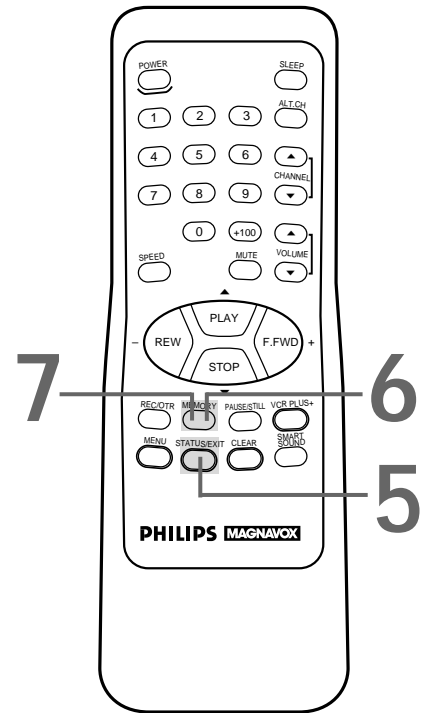

### Helpful Hints

- The counter cannot be memorized or reset when you are using this feature.
- Positions A and B will be erased when a tape is ejected or when you press the REC(ord)/OTR button.
- If the TV/VCR is turned off when you are using this feature, the TV/VCR will memorize positions A and B.
- A-B REPEAT will not appear on-screen at step 5 if a tape is not in the TV/VCR. NO CASSETTE will flash on-screen briefly.
- You cannot rewind or fast forward beyond points A or B when you are using this feature.

## 48 Real Time Counter Memory

Follow the steps below to reset the real time counter to zero at a tape location you want to refer to later.

# 1

Play, fast forward or rewind a tape to the location that you would like to refer to later. Stop the tape.

# 2

Press the **STATUS/EXIT** button. The real time counter will appear on-screen.

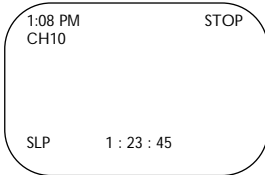

# 3

While the counter remains on-screen, press the **CLEAR** button to reset the real time counter to zero.

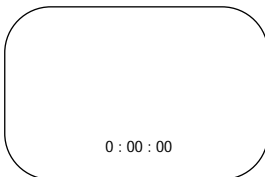

# 4

While the counter remains on-screen, press the **MEMORY** button so that **M** appears on-screen. To erase a time counter memory, press the **MEMORY** button so that the **M** disappears from the screen.

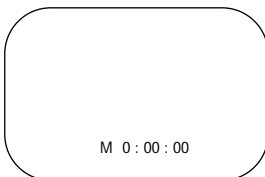

# 5

To return to the previous point at which the real time counter was reset to zero, when in Stop mode, press the **REW(ind)-** button. To return to the future point at which the time counter was reset to zero, when in Stop mode, press the **F.FWD/+** button. Wait for the tape to stop, then press the **PLAY/▲** button to watch the tape.

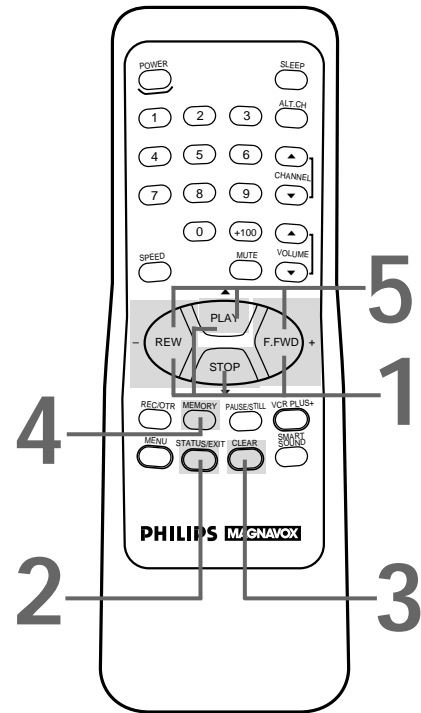

### Helpful Hints

- The time counter memory will not function during Repeat Play mode. Details are on page 45.
- You may only set one time counter memory at a time. If you try to set the time counter to zero at a second location, the previous time counter to zero setting will be lost.



## Automatic Operation Features 49

---

The following playback features will always operate:

### Automatic Playback

When you put a tape in the TV/VCR, the power will come on automatically. If the tape's record tab is missing, playback will begin. (If a timer recording is set, you may have to press the POWER button to turn on the TV/VCR.)

### Automatic Rewind, Eject, Off

When a tape is played, fast forwarded, or recorded to its end, the TV/VCR will rewind the tape, stop, turn itself off, then eject the tape. If a tape counter memory is set, the TV/VCR will only rewind the tape to the point at which the tape counter was set to zero, then stop. The TV/VCR will not turn itself off or eject the tape.

### Memory Rewind, Power Off

When the POWER button is pressed while the TV/VCR is rewinding a tape, REW → POWER OFF will appear on-screen. The TV/VCR will turn itself off when the tape has finished rewinding. If a tape counter memory is set, the TV/VCR may only rewind the tape to the point at which the tape counter was set to zero, then turn itself off.

### Tape Eject

A tape can be ejected with the TV/VCR power on or off (but the TV/VCR must be plugged in). If a timer recording is programmed, a tape can not be ejected when the power is off. Turn on the TV/VCR power, then eject the tape. Be sure to insert a tape and turn off the TV/VCR power for the timer recording.

### Automatic Tracking Adjustment

The TV/VCR has automatic tracking, which continually adjusts tracking to give you the best possible picture quality. With some recordings, however, you may get a better picture using the manual tracking controls (see below).

### Manual Tracking

To adjust the tracking manually during tape playback, press the CHANNEL Up/Down buttons on the TV/VCR.

#### NOTES:

- To return tracking to the position it was in when the TV/VCR was shipped from the factory, press the CHANNEL Up/Down buttons **on the TV/VCR at the same time**.
- Tracking is returned to automatic tracking when a tape is inserted, or when the STOP/▼ button is pressed to halt playback.

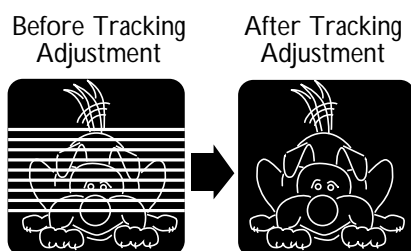

## 50 Playback Options

### Forward and Reverse Searching (SP/LP/SLP)

1

When in Play mode, press and release the F.FWD/+ button or the REW(ind)/- button. A fast forward or reverse picture search will begin.

2

To return to normal playback, press the PLAY/▲ button.

### Super High Speed Searching (LP/SLP)

1

When in Play mode, press the F.FWD/+ button or the REW(ind)/- button, then press again. The TV/VCR will now search in super high speed.

2

To return to normal playback, press the PLAY/▲ button.

### Viewing a Still Picture

1

When in Play mode, press the PAUSE/STILL button. A still picture (frozen image) will appear on-screen. The noise lines will move each time you press the PAUSE/STILL button.

2

To release the still picture and return to normal playback, press the PLAY/▲ button.

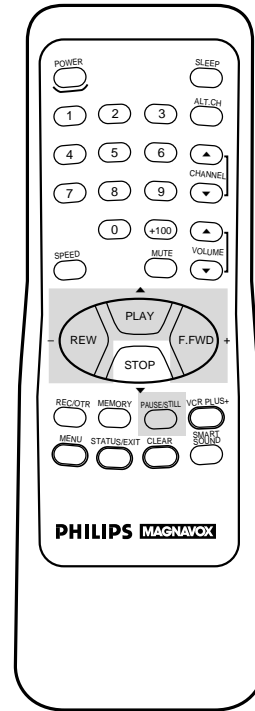

#### Helpful Hints

- Still mode will automatically switch to Stop mode after five minutes to protect the TV/VCR and the tape from damage.
- SP/LP/SLP means this feature will work with tapes recorded in Standard Play, Long Play, or Super Long Play. For details about tape speed, see page 29.
- LP/SLP means this feature will work with tapes recorded in Long Play and Super Long Play. For details on tape speed, see page 29.
- If a still picture vibrates vertically, stabilize it by pressing the CHANNEL (Up/Down) buttons on the TV/VCR.
- During forward and reverse searching, horizontal noise bars will appear on the TV/VCR screen.

## Specifications

### General

CRT: 13-inch in line gun  
Television system: NTSC-M  
Closed caption system: Section 15.119, FCC  
(Federal Communications Commission) Standard  
Video Heads: Two heads  
Tape width: 1/2 inch (12.65 mm)  
Tape speed  
    SP: 33.35 mm/sec.  
    LP: 16.67 mm/sec.  
    SLP: 11.12 mm/sec.  
Operating Temperature: 41°F (5°C) to 104°F (40°C)  
Relative Humidity: 10% to 75%  
Power requirement: AC 120V, 60Hz  
Power consumption: 75W  
Sound output: 1W  
Dimensions:  
    15-13/16" (H) x 15-3/16" (W) x 14-3/4" (D)  
    402 mm x 386 mm x 375 mm  
Weight: 27.5 lbs (12.5 kg)

### Tuner Broadcast Channels

VHF 2-13, UHF 14-69

### CATV Channels

Midband: A – 1  
Superband: J – W  
Hyperband: A-5 – A-1  
Special Channel: 5A  
Ultraband: 37 – 94, 100 – 125

### Terminals

Antenna IN: VHF/UHF 75 ohms unbalanced  
Video IN: RCA connector  
Audio IN: RCA connector  
Earphone: 3.5 mm CES

### Electrical Specifications

Video input level: 0.5~2.0Vp-p  
Audio input level: -10dBv  
Video S/N ratio  
    SP: More than 42dB $\mu$   
Audio S/N ratio  
    SP: More than 38dB

*Designs and specifications are subject to change without notice and without our legal obligation.*

## Glossary

**AUDIO Jack:** jack located on the front of the TV/VCR which is used to record audio from another source.

**Automatic Channel Programming:** process in which the TV/VCR scans all available channels and places the ones you receive in its memory. Then, when you push the CHANNEL (Up/Down) buttons, you only scan through channels you receive.

**Bands:** settings that allow you to tune channels.

- **Antenna** – VHF (very high frequency; channels 2 - 13) and UHF (ultra high frequency; channels 14 - 69).
- **Cable** – all standard channels can be received without a Cable Box.

**Brightness:** adjusting increases or decreases the brightness of the color on-screen.

**Color:** adjusting pales or brightens the TV/VCR color.

**Dubbing:** copying a tape using a VCR.

**HQ:** high quality; a feature in the TV/VCR circuitry which provides enhanced picture detail.

**Line Input:** The channel to which you set your TV/VCR during dubbing. The line input channel is always channel 00 (A/V IN).

**Mode:** a TV/VCR operation.

**OTR:** one touch recording; programming a timed recording that starts immediately and records for 30 minutes to eight hours, whichever you specify.

**Picture:** adjust to increase or decrease the contrast of the picture on-screen.

**Sharpness:** adjusting softens or clarifies the picture on-screen.

**Tape Speeds:** how fast the tape travels during playback or a recording.

- **SP** (standard play) – fastest tape speed (recording time for a T120 tape is approximately two hours); best picture quality.
- **LP** (long play) – average tape speed (recording time for a T120 tape is approximately four hours).
- **SLP** (super long play) – slowest tape speed (recording time for a T120 tape is approximately six hours).

**Tint:** adjusting changes the tints of the picture on the TV/VCR from purple to green.

**VCR:** video cassette recorder.

**VIDEO Jack:** jack located on the front of the TV/VCR which is used to record video from another source.

## 52 Helpful Hints

---

If you are having problems with your TV/VCR, check this list of problems and possible solutions before requesting service. You may be able to solve the problem yourself.

### Location

For safe operation and satisfactory performance of your TV/VCR, remember the following:

- Shield it from direct sunlight and keep it away from sources of intense heat.
- Avoid dusty or humid places.
- Avoid places with insufficient ventilation. Do not block the ventilation openings at the top and bottom of the TV/VCR. Do not place the TV/VCR on a carpet, as this will block the ventilation openings.
- Avoid locations subject to strong vibrations.
- Do not place the TV/VCR near strong magnetic fields.
- Do not move the TV/VCR from a cold place to a hot place, or vice versa.

### Time Selection

12 AM = Midnight

12 PM = Noon

### Electrical Shock and Fire Hazards

- Do not handle the power cord with wet hands.
- Do not pull the power cord when disconnecting the TV/VCR from the AC (alternating current) wall outlet. Grasp it by the plug.
- If water is spilled on the TV/VCR, unplug the power cord immediately and take the TV/VCR to an authorized service center.
- Do not put your fingers or objects into the TV/VCR cassette compartment.
- Do not place anything on top of the TV/VCR.

### Dew Warning

- Moisture condensation may occur inside the unit when it is moved from a cold place to a warm place, after heating a cold room, or when the humidity is high. There is no warning that moisture has accumulated in your TV/VCR. But, if you try to play a tape in a TV/VCR in which moisture has accumulated, the tape and the TV/VCR could be damaged. Therefore, if you try to play a tape and the tape is destroyed, and you think moisture may have accumulated inside the TV/VCR, keep the TV/VCR power on (but do not play a tape) for at least two hours. This will allow the TV/VCR to dry.

### TV/VCR will not record.

- Make sure the tape has a record tab (page five).

### TV/VCR will not perform a timer recording.

- Make sure the recording start and stop times are set correctly (pages 32 - 39).
- Make sure the TV/VCR power is off.
- Make sure the clock is set (pages 12 - 17).
- Make sure there is a tape in the TV/VCR. The tape must have a record tab.
- Make sure the power has not failed. The TV/VCR may not perform or continue a timer recording if a power interruption of more than one minute occurs before or during the timer recording, even if the power comes back on.
- Make sure the TV/VCR is not in Record Defeat mode (page 40).

### TV/VCR will not perform a one touch recording.

- Make sure the tape has a record tab (page five).
- Make sure the TV/VCR is not in Record Defeat mode (page 40).
- Plug the power cord into an active AC outlet (page seven).
- Check your hookups (pages six - seven).
- Program channels (page 10).

### **TV/VCR has no power.**

- Make sure the power plug is completely connected to an AC (alternating current) outlet.

### **A power failure occurred.**

- Follow the steps on page eight to select a language and program channels, if necessary. Then set the clock (pages 12 - 17).

### **TV/VCR power shuts off after 15 minutes.**

- To save energy, the TV/VCR will shut itself off after 15 minutes when it is on a channel that is not receiving a broadcast signal (for example, a station that has gone off the air for the night). This is normal.

### **Channel reception is poor.**

- Check connections, then program channels again (page 10).

### **TV/VCR does not have a picture.**

- Adjust the antenna (pages six - seven).
- Connect the antenna or cable directly to the TV/VCR.
- Adjust the TV/VCR picture controls (pages 24 - 25).

### **TV/VCR has poor sound or no sound.**

- Adjust the volume.
- Press the MUTE button to restore the volume.

### **Tape playback is poor or tape is destroyed.**

- Adjust the tracking. *Details are on page 49.*
- If moisture has accumulated in your TV/VCR, keep the power on for at least two hours, but do not try to play a tape. *Details are on page 52.*

### **TV/VCR does not display closed captioning.**

- Cancel Counter Only mode. *Details are on page 26.*
- Make sure closed captioning is available for the program. Refer to the TV listings in your local newspaper.

### **Remote control does not operate TV/VCR.**

- Aim the remote control directly at the TV/VCR's remote sensor. *Details are on pages five and 20.*
- Remove all obstacles between the remote control and the TV/VCR.
- Inspect and replace the batteries in the remote control. *Details are on page five.*

### **Number buttons won't work for channels above 69.**

- Select CABLE from the INPUT section of the pop up menu, then let the TV/VCR program the channels. *Details are on page 10.*

### **TV/VCR can't receive channels above 13.**

- Select CABLE from the INPUT section of the pop up menu, then let the TV/VCR program the channels. *Details are on page 10.*

### **A tape can't be inserted into the TV/VCR.**

- Insert the tape window side up, with the record tab facing you.
- Make sure a tape isn't already in the TV/VCR by pressing the STOP/EJECT button on the TV/VCR.
- Gently push on the center of the tape. Never force a tape into the TV/VCR.

### **A tape can't be removed from the TV/VCR.**

- Make sure the power plug is completely connected to an AC (alternating current) outlet.
- If a timer recording is programmed, turn on the TV/VCR power, then eject the tape. Be sure to insert a tape and turn off the TV/VCR power for the timer recording.

### **TV/VCR ejects the tape when you try to start a recording.**

- Make sure the tape has a record tab. *Details are on page five.*

### **The cylinder rotates when the TV/VCR is in Stop mode.**

- To enable the quick play mechanism, the cylinder will rotate for about five minutes. This is normal.

### **Daylight-Saving Time**

- When Daylight-Saving Time is ON, the clock time will change automatically as follows: on the first Sunday of April, from 2 a.m. to 3 a.m.; on the last Sunday of October, from 2 a.m. to 1 a.m.
- When programmed timer recordings start between 2 a.m. and 2:59 a.m. on the first Sunday of April, the TV/VCR will start recording at 3 a.m. (summer time).
- When programmed timer recordings end between 2 a.m. and 2:59 a.m. on the first Sunday of April, the TV/VCR will stop at 3 a.m.
- When using this feature, a program that occurs during the spring time change may not record completely. Adjust the start and stop times accordingly.

## 54 Limited Warranty

### TV/VCR COMBINATION

90 Days Free Labor/One Year Free Parts Exchange (Two Years Free Exchange on Color Picture Tube)  
This product must be carried in for repair.

#### WHO IS COVERED?

You must have proof of purchase to receive warranty service. A sales receipt or other document showing that you purchased the product is considered proof of purchase.

#### WHAT IS COVERED?

Warranty coverage begins the day you buy your product. For 90 days thereafter, all parts will be repaired or replaced, and labor is free. From 90 days to one year from the day of purchase, all parts will be repaired or replaced, but you pay for all labor charges. From one to two years from the day of purchase, you pay for the replacement or repair of all parts except the picture tube, and for all labor charges. After two years from the day of purchase, you pay for the replacement or repair of all parts, and for all labor charges.

All parts, including repaired and replaced parts, are covered only for the original warranty period. When the warranty on the product expires, the warranty on all replaced and repaired parts also expires.

#### WHAT IS EXCLUDED?

Your warranty does not cover:

- labor charges for installation or setup of the product, adjustment of customer controls on the product, and installation or repair of antenna systems outside of the product.
- product repair and/or part replacement because of misuse, accident, unauthorized repair or other cause not within the control of Philips Consumer Electronics Company.
- reception problems caused by signal conditions or cable or antenna systems outside the unit.
- a product that requires modification or adaptation to enable it to operate in any country other than the country for which it was designed, manufactured, approved and/or authorized, or repair of products damaged by these modifications.
- incidental or consequential damages resulting from the product. (Some states do not allow the exclusion of incidental or consequential damages, so the above exclusion may not apply to you. This includes, but is not limited to, prerecorded material, whether copyrighted or not copyrighted.)
- damage caused by the use of non-VHS tapes or tapes that have not been tested and labeled for use in two, four, six, and eight hour VHS recorders.
- a product that is used for commercial or institutional purposes.

#### WHERE IS SERVICE AVAILABLE?

Warranty service is available in all countries where the product is officially distributed by Philips Consumer Electronics Company. In countries where Philips Consumer Electronics Company does not dis-

tribute the product, the local Philips service organization will attempt to provide service (although there may be a delay if the appropriate spare parts and technical manual(s) are not readily available).

#### MAKE SURE YOU KEEP...

Please keep your sales receipt or other document showing proof of purchase. Attach it to this owner's manual and keep both nearby. Also keep the original box and packing material in case you need to return your product.

#### BEFORE REQUESTING SERVICE...

Please check your owner's manual before requesting service. Adjustments of the controls discussed there may save you a service call.

#### TO GET WARRANTY SERVICE IN U.S.A., PUERTO RICO OR U.S. VIRGIN ISLANDS...

Take the product to a Philips factory service center (see enclosed list) or authorized service center for repair. When the product has been repaired, you must pick up the unit at the center. Centers may keep defective parts.

(In U.S.A., Puerto Rico and U.S. Virgin Islands, all implied warranties, including implied warranties of merchantability and fitness for a particular purpose, are limited in duration to the duration of this express warranty. But, because some states do not allow limitations on how long an implied warranty may last, this limitation may not apply to you.)

#### TO GET WARRANTY SERVICE IN CANADA...

Please contact Philips at:

1-800-661-6162 (French Speaking)

1-800-363-7278 (English Speaking)

(In Canada, this warranty is given in lieu of all other warranties. No other warranties are expressed or implied, including any implied warranties of merchantability or fitness for a particular purpose. Philips is not liable under any circumstances for any direct, indirect, special, incidental or consequential damages, howsoever incurred, even if notified of the possibility of such damages.)

#### REMEMBER...

Please record below the model and serial numbers found on the product. Also, please fill out and mail your warranty registration card promptly. It will be easier for us to notify you if necessary.

MODEL # \_\_\_\_\_

SERIAL # \_\_\_\_\_

*This warranty gives you specific legal rights. You may have other rights which vary from state to state.*

**Philips Service Company, P.O. Box 555, Jefferson City, Tennessee 37760, (423) 475-8869**



---

a-b repeat playback . . . . .	46 - 47	button . . . . .	23	super long play . . . . .	29, 51
accessories . . . . .	56	real time counter . . . . .	48	table of contents . . . . .	4
ant(enna) jack . . . . .	6, 21	rewind, power off . . . . .	49	tape	
audio jack . . . . .	7, 20	menu button . . . . .	22	duplication . . . . .	31
automatic		mute button . . . . .	23	speed . . . . .	29, 51
playback . . . . .	49	number buttons . . . . .	22	time	
rewind . . . . .	49	on-screen-off mode . . . . .	26	setting . . . . .	12 - 17
batteries . . . . .	5	on-screen-on mode . . . . .	26	zone . . . . .	19
brightness, adjusting . . . . .	24 - 25	one touch recording . . . . .	30	timer recording	
cassette (see tape)		pause/still button . . . . .	23, 50	cancelling . . . . .	35
cassette compartment . . . . .	20	picture, adjusting . . . . .	24 - 25	reviewing . . . . .	35
channel		play button . . . . .	20, 22	setting . . . . .	32 - 34
above 100 . . . . .	22	playback options . . . . .	50	with vcr plus+ programming	
adding . . . . .	11	playing . . . . .	28	system . . . . .	36-39
deleting . . . . .	11	power		tint, adjusting . . . . .	24 - 25
memory . . . . .	10	button . . . . .	20, 22	tracking . . . . .	49
programming . . . . .	10	cord . . . . .	7	vcr plus+	
reviewing . . . . .	11	rear panel . . . . .	21	button . . . . .	23
up/down buttons . . . . .	20, 23, 49	rec/otr button . . . . .	20, 22	(setting) . . . . .	36 - 37
clear button . . . . .	23	rec(ord) light . . . . .	20	timer recording . . . . .	38 - 39
clock . . . . .	12 - 17	record defeat . . . . .	40	video	
closed caption system . . . . .	42 - 43	recording . . . . .	29	jack . . . . .	7, 20
color, adjusting . . . . .	24 - 25	reminder . . . . .	27	tape (see tape)	
connections . . . . .	6 - 7	remote		volume bar . . . . .	44
contents, table of . . . . .	4	control		warranty . . . . .	54
controls		buttons . . . . .	22 - 23		
remote . . . . .	22 - 23	using . . . . .	5		
tv/vcr . . . . .	20 - 21	sensor . . . . .	20		
counter memory . . . . .	48	repeat playback . . . . .	45		
counter only mode . . . . .	26	rerecording . . . . .	31		
daylight-saving time . . . . .	18	rew(ind) button . . . . .	20, 22, 50		
duplication . . . . .	31	rewinding . . . . .	50		
earphone jack . . . . .	20	safety precautions . . . . .	3		
erase protection . . . . .	5	searching . . . . .	50		
fast forward search . . . . .	50	sensor (remote) . . . . .	20		
f.fwd button . . . . .	20, 23, 50	sharpness, adjusting . . . . .	24 - 25		
front panel . . . . .	20	sleep timer . . . . .	41		
glossary . . . . .	51	slp . . . . .	29, 51		
hookups . . . . .	6 - 7, 31	smart sound			
helpful hints . . . . .	52 - 53	button . . . . .	22		
language selection . . . . .	9	setting . . . . .	44		
line input mode . . . . .	10, 31, 51	sp . . . . .	29, 51		
long play . . . . .	29, 51	standard play . . . . .	29, 51		
lp . . . . .	29, 51	status display . . . . .	26		
memory		status/exit button . . . . .	22		
		still picture . . . . .	50		
		stop button . . . . .	23		
		stop/eject button . . . . .	20		
		super high speed searching . . . . .	50		

# SUPPLIED ACCESSORIES

**Check to be sure the items on this page are packed with your TV/VCR. These accessories are provided to help you use or set up your TV/VCR.**

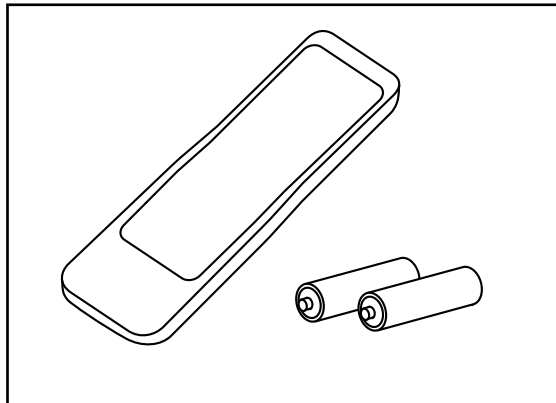

**Remote Control (4835 218 37203)  
Two AA Batteries (4835 138 17012)**

***If any of these items are not included, or if you need to replace an item, contact Philips Service Company at the address below.***

***Philips Service Company  
P.O. Box 967  
Greeneville, TN 37744-0967***

***Or, call 1-800-851-8885.***